

MOTIVO

furniture

A Division of Ariston Hospitality

2022 Catalog

Volume 8

MOTIVO

furniture

A Division of Ariston Hospitality

WELCOME TO MOTIVO FURNITURE

Motivo Furniture, a division of Ariston Hospitality, offers an extensive curated collection of over 200 European-designed chairs, tables, and table bases that are assembled, finished and upholstered domestically in either our High Point, NC or Alhambra, CA facilities. Motivo supplies the North American hospitality, design, contract, and related trade markets with a fashion-forward collection of fine quality products for multiple types of design and installation requirements.

IN-LINE PRODUCTS AND CUSTOM CAPABILITIES

All our standard in-line exposed wood seating, wood table bases and tops are produced in select European beech, made to exacting specifications and industry acceptable contract-grade construction including assembly, application of foam products (TB 117-2013), materials and wood finishes. In addition, Motivo offers a three-year warranty and meets or exceeds applicable BIFMA or ANSI standards, are CATAS tested, and our superior conversion varnish wood finishes pass KCMA testing for industrial use.

The Motivo West Collection, produced in our west coast facility, provides an assortment of seating products with mixed materials, including injection foam molding, exposed metal bases and legs, and unique bent wood seat shells. All incorporate the same contract grade construction and materials used throughout the Motivo product line.

FOR MORE INFORMATION

Motivo Furniture products are marketed through a national network of independent sales representatives. Motivo is an approved vendor for many hotel brands and cruise lines. Our website allows for the download of individual catalog cut sheets and lists our most current installations. Lead times are 8-10 weeks.

We welcome the opportunity to provide our unique seating and table products for your current and future project needs.



arm chairs



Addy-PO-01



Alan-P



Aldo-SCL



Amarcord-P



Ashley



Babbs -PO-01



Brooks



Carrey



Carson



Chappie-SB



Cometa



Danny-L7



Danny-P4



Danny-S5



Espirito



Fully-P



Grotto



Hana-Metal



Impala



Jerry



Karen-L7



Karen-S5



Luna-P



Madre



Matthew-Metal



Mayata-P



Mira



Nance



Nicky



Nina



Oval-PL



Perla-1P



Raymond-262



Rodney



Rover-P



Sandra-C



Scoop-C



Scoop-FP



Scoop-SL



Scoop-TRC



Serena-P



String-1-Stacking



String-B-Stacking



Sunny-PB



Sunny-PC



Timeless-P



Tormalina-1P



Tormalina-3P



Vidal-Metal



Villa-9167A



Vivian-Metal



Ziggy



Ziggy-1



Ziggy-S

side chairs



Addy-SE-01



Amarcord-IMP-Stacking



Babbs-SE-01



Benny-SL



Benny-TR



Berta-1-SCL



Boca



Brooks



Chappie-S



Clara-SE-02



Cometa-B



Criss Cross-1



Criss Cross-2



Dante



Dante-Metal



David



Espirito



Friday-SI-Special-Stacking



Friday-SI-Stacking



Friday-SL-Stacking



Fully



Gipsy-S



Grotto



Jamie



Jamie-Metal



Jerry



Kramer



Ksenia-I



Ksenia-Wood



Leno-Metal



Lewis-SE-01



Lewis-SE-01-20 Metal



Lola



Lola-Metal



Luna-S



Madre



Mayata Standard*



Mira



Nance



Nicky



Noble-223



Noel



Oliver



Oliver-Metal



Oliver-Swivel



Oval-SD



Perla-1 Standard*



Pilla-Stacking



Pippa



Pippa-Metal



Rover-S



Sandra



Sempre-High-9235-S



Sempre-Low-9236-S



Serena



Sunny-SB



Sunny-SC



Tammy-C
(multiple base options)



Timeless-S



Tormalina



Tormalina-1



Toto



Villa-9167S

* = available with stretcher

bar stools



Aldo-SG-SCL



Amarcord-SG



Babbs-SG-01



Benny S65-Oak Stacking



Benny-SH-Oak



Berta -1-SG-SC



Boca



Brooks



Chappie-SG



Clara-SG-02



Cometa-SG



Criss Cross-3



Criss Cross-4



Dante



Dante-Metal



Espirito



Friday-SG-SI



Friday-SG-SI-Special



Friday-SG-SL



Fully-SG



Gipsy-SG



Grotto -SG-SCL



Grotto-SG-SCL-ARMS



Hana-Metal



Jamie



Jamie-Metal



Jerry



Ksenia-1-SG



Ksenia-SG-Wood



Leno-Metal



Lola



Lola-Metal



Madre



Nicky



Noble-226



Noel-SG



Oliver



Oliver-Metal



Oval-SG



Pippa



Pippa-Metal



Raymond-263



Sandra-SG



String-1 SG



Sunny-SG-SB



Sunny-SG-SC



Tammy-SH



Timeless-SG



Tormalina-SG



Tormalina-1SG



Vidal-Metal



Villa-9167B

loveseats / sofas



Ambra-D



Fully-Sofa



Madre



Noble-234

lounge / occasional chairs



Addy-PL-01



Albie -PCL



Amarcord-L



Amarcord-O



Amber



Ambra-PG



Babbs-PL-01



Babbs-PL-02



Babbs-PL-03



Babbs-PL-04



Carrey



Espirito



Fallon-14



Fallon-31



Fully-L Lounge



Gypsy-XL



Homer



Ksenia-Lounge



Lewis-PL-01



Madre Swivel



Nicky



Noble-228



Odyssey



Oval-PPL



Raymond-264



Raymond-265



Toto



Vidra-XL

pedestal / task chairs



Albie-PC-1



Albie-PCR



Aldo-SC-1



Danny-D1



Danny-R1



Danny-R10



Fallon



Karen-D1



Karen-R1



Karen-R9



Lewis-PL-01-24



Oliver

motivo west collection



Alto
Lounge Chair



Angela-D1
Pedestal Chair



Angela-L3
Arm Chair



Angela-P4
Arm Chair



Angela-R1
Pedestal Chair



Angela-R10
Task Chair



Dana
Occasional Chair



Emma
Occasional Chair



Gabriel
Lounge Chair



Industriale
Arm Chair



Isolano
Curved Bench



James
Loveseat



James
Occasional Chair



Lucas
Lounge Chair



Milano
Lounge Chair



Punto
Sectional



Quincy
Lounge Chair



Quincy
Occasional Chair



Solo
Lounge Chair



William
Lounge Chair



William
Loveseat

tables - wood



Madre Oval Coffee



Madre Round End



Micah Coffee



Micah End



Monty Round End



Monty Square End



Plaza End



Soho Coffee



Soho End

table bases - metal



Cage Coffee
BASE ONLY



Cage Dining
BASE ONLY



Cage End
BASE ONLY



Ganty Round Dining
BASE ONLY



Ganty Square Dining
BASE ONLY



TB-256-BT-SS*
Bar Table
BASE ONLY



TB-256-DT-SS*
Dining Table
BASE ONLY



TB-256-ET-SS*
End Table
BASE ONLY



TB-290-1-ET-SS*
End Table
BASE ONLY



TB-290-3-BT-SS*
Bar Table
BASE ONLY



TB-290-3-DT-SS*
Dining Table
BASE ONLY



TB-355-1-CT-PC*
Coffee Table
BASE ONLY



TB-355-1-ET-PC*
End Table
BASE ONLY



TB-355-2-BT-PC*
Bar Table
BASE ONLY



TB-355-2-DT-SS*
Dining Table
BASE ONLY



TB-355-3-DT-PC*
Dining Table
BASE ONLY

*available in stainless steel (SS) and powder coated (PC) finishes

gallery photos



Carrey Arm and Lounge Chairs



Homer Lounge Chair



Dana Occasional Chair



Gabriel Lounge Chair



Alto Lounge Chair



Babbs-PL-03 Lounge Chair



Occasional Chair
ADDY-PL-01

W	D	H	AH	SH
30.75	27.25	30.75		16.75
COM YDS	COL SQ. FT.	CU. FT.	QTY/CT	LBS.
2.75	46.75	18.36	1.00	33.07

beech wood occasional chair with tight seat and back-welt on frame-top and/or single stitched based on COM-minimum quantity required: 25





**Arm Chair
ADDY-PO-01**

W	D	H	AH	SH
26.50	24.00	32.25		19.00
COM YDS	COL SQ. FT.	CU. FT.	QTY/CT	LBS.
1.75	29.75	14.13	1.00	24.25

beech wood arm chair with tight seat and back-welt on frame-top and/or single stitched based on COM-minimum quantity required: 25





Side Chair
ADDY-SE-01

W	D	H	AH	SH
20.25	23.00	34.75		19.00
COM YDS	COL SQ. FT.	CU. FT.	QTY/CT	LBS.
1.75	29.75	14.13	2.00	35.27

beech wood side chair with tight seat and back-welt on frame-top and/or single stitched based on COM-minimum quantity required: 25





**Arm Chair
ALAN-P**

W	D	H	AH	SH
23.25	21.75	32.75	26	19.75
COM YDS	COL SQ. FT.	CU. FT.	QTY/CT	LBS.
2.25	38.25	12.36	1	28.66

beech wood arm chair with tight seat and back-no welt



**Pedestal Chair
ALBIE-PC-1**

W	D	H	AH	SH
24	24.75	28.5	23	18.00
COM YDS	COL SQ. FT.	CU. FT.	QTY/CT	LBS.
2.25	38.25	9.18	1	57.5

beech wood framed seat-fixed height swivel-polished chrome base-welt at back-top and/or single stitched based on COM-multiple base options available



Occasional Chair
ALBIE-PCL

W	D	H	AH	SH
24	24.75	28.5	23	18.00
COM YDS	COL SQ. FT.	CU. FT.	QTY/CT	LBS.
2.25	38.25	10.95	1	27.75

beech wood occasional chair-tight seat and back-welt on frame-top and/or single stitched based on COM-multiple base options available



**Task Chair
ALBIE-PCR**

W	D	H	AH	SH
24	24.75	28.5-31.5	23-26	18-21
COM YDS	COL SQ. FT.	CU. FT.	QTY/CT	LBS.
2.25	38.25	10.95	1	34.25

beech wood framed seat-adjustable height swivel-5 star polished chrome base-welt at back-top and/or single stitched based on COM-multiple base options available



Pedestal Chair
ALDO-SC-1

W	D	H	AH	SH
21	20.75	28.5	25	18.5
COM YDS	COL SQ. FT.	CU. FT.	QTY/CT	LBS.
2.25	38.25	8.83	1	42

beech wood framed seat-fixed height swivel-polished chrome base-welt at back-multiple base options available



**Arm Chair
ALDO-SCL**

W	D	H	AH	SH
21	20.75	25	24	18.5
COM YDS	COL SQ. FT.	CU. FT.	QTY/CT	LBS.
2.25	38.25	8.83	1	24.25

beech wood arm chair-tight seat and back-welt at back-multiple base options available



Bar Stool
ALDO-SG-SCL

W	D	H	AH	SH
21	19	41	37.5	31.75
COM YDS	COL SQ. FT.	CU. FT.	QTY/CT	LBS.
2.25	38.25	12.01	1	26.5

beech wood bar stool-tight seat and back-welt at back-seat and back
single stitched-metal foot rail-multiple base options available



**Lounge Chair
ALTO**

W	D	H	AH	SH
27	35	42.5	21.75	17
COM YDS	COL SQ. FT.	CU. FT.	QTY/CT	LBS.
6	108	31	1	29

fully upholstered, inside and outside, bent wood seat shell with black metal powder coated base/legs (ML 03)-top and double needle stitched-welt-minimum quantity required: 2





Side Chair
AMARCORD-IMP-STACKING

W	D	H	AH	SH
18	19.5	33.25		18.5
COM YDS	COL SQ. FT.	CU. FT.	QTY/CT	LBS.
0.5	8.5	10.59	2	33

beech wood side chair with tight seat and wood back-stacking-6





**Occasional Chair
AMARCORD-L**

W	D	H	AH	SH
26	22.75	30.75	24	18
COM YDS	COL SQ. FT.	CU. FT.	QTY/CT	LBS.
1	17	9.54	1	24

beech wood occasional chair with tight wrapped seat and wood back





Occasional Chair
AMARCORD-O

W	D	H	AH	SH
22	24	29.50		18
COM YDS	COL SQ. FT.	CU. FT.	QTY/CT	LBS.
1.50	25.50	11.30	1	26.46

beech wood occasional chair with fixed seat cushion-welt





Arm Chair
AMARCORD-P

W	D	H	AH	SH
22	20.25	33.5	26.5	18.5
COM YDS	COL SQ. FT.	CU. FT.	QTY/CT	LBS.
0.75	12.75	11.30	1	26

beech wood arm chair with tight seat and wood back





Bar Stool
AMARCORD-SG

W	D	H	AH	SH
16	19.25	39.5		30
COM YDS	COL SQ. FT.	CU. FT.	QTY/CT	LBS.
0.5	8.5	9.89	1	23

beech wood bar stool with tight seat and wood back-black nylon foot rail





Occasional Chair
AMBER

W	D	H	AH	SH
29	33	35.5	25.5	18.5
COM YDS	COL SQ. FT.	CU. FT.	QTY/CT	LBS.
4.5	76.5	19.42	1	80

beech wood occasional chair with wood base-tight seat and back-top and/or single stitched based on COM



**Loveseat
AMBRA-D**

W	D	H	AH	SH
51.50	25.75	30.75	24	16.50
COM YDS	COL SQ. FT.	CU. FT.	QTY/CT	LBS.
4	72	28.25	1	52.91

beech wood loveseat with tight seat and back-welt on frame-top and/
or single stitched based on COM



**Occasional Chair
AMBRA-PG**

W	D	H	AH	SH
26	24	30.75	24.50	16.50
COM YDS	COL SQ. FT.	CU. FT.	QTY/CT	LBS.
2.75	46.75	19.07	1	37.48

beech wood occasional chair with tight seat and back-welt on frame-top and/or single stitched based on COM



**Pedestal Chair
ANGELA-D1**

W	D	H	AH	SH
24.50	23.75	31	24	18
COM YDS	COL SQ. FT.	CU. FT.	QTY/CT	LBS.
1.75	29.75	12.40	1	60.39

arm chair-bent wood seat shell-polished stainless steel base-swivel-top and/or single stitched based on COM-KD-assembly required-2 cartons-minimum quantity required: 10



Arm Chair
ANGELA-L3

W	D	H	AH	SH
24.50	23.75	31	24	18
COM YDS	COL SQ. FT.	CU. FT.	QTY/CT	LBS.
1.75	29.75	11.40	1	29.24

arm chair-bent wood seat shell-beech wood base/legs-top and/or single stitched based on COM-minimum quantity required: 10



**Arm Chair
ANGELA-P4**

W	D	H	AH	SH
24.50	23.75	31	24	18
COM YDS	COL SQ. FT.	CU. FT.	QTY/CT	LBS.
1.75	29.75	11.40	1	29.24

arm chair-bent wood seat shell-polished chrome legs-top and/or single stitched based on COM-minimum quantity required: 10



Pedestal Chair
ANGELA-R1

W	D	H	AH	SH
24.50	23.75	31	24	18
COM YDS	COL SQ. FT.	CU. FT.	QTY/CT	LBS.
1.75	29.75	12.40	1	43.86

arm chair-bent wood seat shell-polished chrome base-top and/
or single stitched based on COM-swivel-KD-assembly required-2
cartons-minimum quantity required: 10



**Task Chair
ANGELA-R10**

W	D	H	AH	SH
24.50	23.75	31-34	24-27	18-21
COM YDS	COL SQ. FT.	CU. FT.	QTY/CT	LBS.
1.75	29.75	12.40	1	39.45

arm chair-bent wood seat shell-polished chrome legs-top and/or single stitched based on COM-swivel-gas lift-KD-assembly required-2 cartons-minimum quantity required: 10



Arm Chair
ASHLEY

W	D	H	AH	SH
23	23.75	32	25	19

COM YDS	COL SQ. FT.	CU. FT.	QTY/CT	LBS.
3	51	14.13	1	38

beech wood arm chair with tight seat and back-no welt-top and/or single stitched based on COM



**Occasional Side Chair
BABBS-PL-01**

W	D	H	AH	SH
29.5	31.5	30.5		17
COM YDS	COL SQ. FT.	CU. FT.	QTY/CT	LBS.
3	51	19.42	1	42

beech wood occasional chair-tight seat and back-top and/or single stitched based on COM





**Occasional Arm Chair
BABBS-PL-02**

W	D	H	AH	SH
31	31.5	30.5		17
COM YDS	COL SQ. FT.	CU. FT.	QTY/CT	LBS.
3.5	59.5	19.42	1	40

beech wood occasional chair-tight seat and back-top and/or single stitched based on COM





Lounge Chair
BABBS-PL-03

W	D	H	AH	SH
31	32	33		18.5
COM YDS	COL SQ. FT.	CU. FT.	QTY/CT	LBS.
4	68	19.42	1	65

beech wood lounge chair-tight seat and back-top and/or single stitched based on COM





**Arm Chair
BABBS-PO-01**

W	D	H	AH	SH
25	26	32.5	29	18.5
COM YDS	COL SQ. FT.	CU. FT.	QTY/CT	LBS.
2.5	42.5	14.13	1	25.35

beech wood arm chair-tight seat and back-top and/or single stitched based on COM





Side Chair
BABBS-SE-01

W	D	H	AH	SH
23.5	25.5	32.5		18.5
COM YDS	COL SQ. FT.	CU. FT.	QTY/CT	LBS.
2	34	14.13	1	23.5

beech wood side chair-tight seat and back-top and/or single stitched based on COM





Lounge Chair
BABBS-PL-04

W	D	H	AH	SH
31	33	37.5	21.5	17.25
COM YDS	COL SQ. FT.	CU. FT.	QTY/CT	LBS.
3.75	67.5	27.55	1	58

beech wood lounge chair-tight seat and back-no welt-top and/or single stitched based on COM-minimum quantity required: 2

NOTE: FABRIC MUST BE APPROVED FOR APPLICATION-4 WAY STRETCH REQUIRED-center seam or zipper on outside back may be required based on fabric





**Bar Stool
BABBS-SG-01**

W	D	H	AH	SH
22.5	21.75	43.75		31.75
COM YDS	COL SQ. FT.	CU. FT.	QTY/CT	LBS.
1.75	27	14.48	1	24.5

beech wood base/legs bar stool-tight seat and back-no welt-top and/or single stitched based on COM-center seam or zipper on outside back may be required based on fabric-stainless steel foot rail





Bar Stool
BENNY-S-65-STACKING
BENNY-S-78-STACKING

	W	D	H	AH	SH
BENNY-S-65	19.50	18.25	35.00		25.75
BENNY-S-78	20.25	19.50	41.50		30.50
	COM YDS	COL SQ. FT.	CU. FT.	QTY/CT	LBS.
BENNY-S-65			12.36	2	35.27
BENNY-S-78			13.07	2	38.58

seat-multi layered oak (2D) frame-high resistance steel pipe
(ML00, ML01, ML02, ML03) STACKING-6

interchangeable base with other BENNY models-see price list



**Bar Stool
BENNY-SH-OAK**

W	D	H	AH	SH
16.5	18.25	36.25-43.5		26.5-33.5

COM YDS	COL SQ. FT.	CU. FT.	QTY/CT	LBS.
		7.42	1	25.35

seat- multi-layered oak (2D) base-die cast aluminum (ML00, ML01, ML02, ML03) swivel-gas lift

interchangeable base with other BENNY models-see price list



**Side Chair
BENNY-SL**

W	D	H	AH	SH
17.75	20.5	30.75		18.00
COM YDS	COL SQ. FT.	CU. FT.	QTY/CT	LBS.
		13.07	2	30.86

seat- multi-layered oak (2D) frame-high resistant steel tube
(ML00, ML01, ML02, ML03)

interchangeable base with other BENNY models-see price list





Side Chair
BENNY-TR

W	D	H	AH	SH
19	19.75	30.75		18.00
COM YDS	COL SQ. FT.	CU. FT.	QTY/CT	LBS.
		13.07	2	27.12

seat- multi-layered oak (2D) frame-high resistant steel tube
(ML00, ML01, ML02, ML03)

interchangeable base with other BENNY models-see price list





Side Chair
BERTA-1-SCL

W	D	H	AH	SH
21.5	21.75	31.25		18.65
COM YDS	COL SQ. FT.	CU. FT.	QTY/CT	LBS.
2.25	38.25	9.89	1	22

beech wood side chair-tight seat and back-welt at back-multiple base options available





**Bar Stool
BERTA-1-SG-SC**

W	D	H	AH	SH
21.5	21.5	44.5		31.5
COM YDS	COL SQ. FT.	CU. FT.	QTY/CT	LBS.
2.25	38.25	13.42	1	22

beech wood bar stool-tight seat and back-welt at back-metal foot rail-multiple base options available





**Bar Stool
BOCA**

W	D	H	AH	SH
19	22.25	41		30.75

COM YDS	COL SQ. FT.	CU. FT.	QTY/CT	LBS.
1.5	25.5	13.42	1	35

beech wood bar stool-tight seat and back-welt at frame back-metal foot rail



**Side Chair
BOCA**

W	D	H	AH	SH
20.5	20	31.5		18.75
COM YDS	COL SQ. FT.	CU. FT.	QTY/CT	LBS.
1.5	25.5	13.42	2	45

beech wood side chair-tight seat and back-welt at frame back



**Arm Chair
BROOKS**

W	D	H	AH	SH
22.5	25	35	26.75	19.5
COM YDS	COL SQ. FT.	CU. FT.	QTY/CT	LBS.
1.75	31.5	11.65	1	30

beech wood arm chair-tight seat and back-welt at in/out/back-top and/or single stitched seat based on COM





**Side Chair
BROOKS**

W	D	H	AH	SH
21.25	24.50	35		19.50
COM YDS	COL SQ. FT.	CU. FT.	QTY/CT	LBS.
1.75	31.5	16.24	2	46.95

beech wood side chair-tight seat and back-welt at in/out/back-top and/or single stitched seat based on COM





**Bar Stool
BROOKS**

W	D	H	AH	SH
20	22	45.75		31
COM YDS	COL SQ. FT.	CU. FT.	QTY/CT	LBS.
1.50	27	13.07	1	28

beech wood bar stool-tight seat and back-welt at in/out/back-top and/or single stitched seat based on COM-stainless steel foot rail





Arm Chair
CARREY

W	D	H	AH	SH
20.25	25.75	34	26.5	18.5
COM YDS	COL SQ. FT.	CU. FT.	QTY/CT	LBS.
0.75	13.5	13	1	27

beech wood arm chair-tight seat and back-no welt-top and/or single stitched based on COM





Lounge Chair
CARREY

W	D	H	AH	SH
26.5	30	30	23	16.50
COM YDS	COL SQ. FT.	CU. FT.	QTY/CT	LBS.
3	54	16	1	48

beech wood lounge chair-tight seat and back-no welt-top and/or single stitched based on COM





**Arm Chair
CARSON**

W	D	H	AH	SH
23.5	23.5	33	27.5	19
COM YDS	COL SQ. FT.	CU. FT.	QTY/CT	LBS.
1.25	22.50	11.65	1	25

beech wood arm chair-tight seat and back-welt





Side Chair
CHAPPIE-S

W	D	H	AH	SH
19.25	20.50	31.50		18.00
COM YDS	COL SQ. FT.	CU. FT.	QTY/CT	LBS.
1.25	21.25	12.01	2.00	35.27

beech wood side chair with tight seat and upholstered in back/wood out back-welt on seat frame and in back-top and/or single stitched based on COM-stretcher





**Arm Chair
CHAPPIE-SB**

W	D	H	AH	SH
23.25	20.50	31.50	25.25	18.00
COM YDS	COL SQ. FT.	CU. FT.	QTY/CT	LBS.
1.25	21.25	10.95	1.00	26.46

beech wood arm chair with tight seat and upholstered in back/wood out back-welt on seat frame and in back-top and/or single stitched based on COM





Bar Stool
CHAPPIE-SG

W	D	H	AH	SH
19.25	20.00	40.50		30.25
COM YDS	COL SQ. FT.	CU. FT.	QTY/CT	LBS.
1.25	21.25	12.01	1.00	30.86

beech wood bar stool with tight seat and upholstered in back/wood out back-welt on seat frame and in back-top and/or single stitched based on COM-metal foot rail





Side Chair
CLARA-SE-02

W	D	H	AH	SH
19.50	21.75	36.00		19.00
COM YDS	COL SQ. FT.	CU. FT.	QTY/CT	LBS.
1.50	25.50	14.13	2.00	30.86

beech wood side chair with tight seat and back-no welt-top and/or single stitched based on COM





Bar Stool
CLARA-SG-02

W	D	H	AH	SH
18.50	20.25	42.50		30.75
COM YDS	COL SQ. FT.	CU. FT.	QTY/CT	LBS.
1.25	21.25	11.30	1.00	15.43

beech wood bar stool with tight seat and back-no welt-top and/or single stitched based on COM-metal foot rail





**Side Chair
COMETA-B**

W	D	H	AH	SH
24.50	22.50	32.75		19.00

COM YDS	COL SQ. FT.	CU. FT.	QTY/CT	LBS.
3	51	13.07	1	26.46

beech wood side chair (low arm) with tight seat and back-welt-top and/or single stitched based on COM



**Arm Chair
COMETA**

W	D	H	AH	SH
24.50	22.50	32.75	26.50	19.00

COM YDS	COL SQ. FT.	CU. FT.	QTY/CT	LBS.
2.75	46.75	13.07	1	26.46

beech wood arm chair with tight seat and back-welt on frame-top and/or single stitched based on COM



**Bar Stool
COMETA-SG**

W	D	H	AH	SH
17.75	21.25	41.75		29.75
COM YDS	COL SQ. FT.	CU. FT.	QTY/CT	LBS.
1.25	21.25	9.89	1	24.25

beech wood bar stool with tight seat and back-welt on frame-top and/or single stitched based on COM-chrome foot rail-minimum order required with 3/4 back (as shown above)



Side Chair-Upholstered Seat and Back
CRISS CROSS-1

W	D	H	AH	SH
20	22	31		19.75
COM YDS	COL SQ. FT.	CU. FT.	QTY/CT	LBS.
1	18	14.2	2	45

ash wood side chair-tight seat and back-wood out back



Side Chair-Wood Seat and Back
CRISS CROSS-2

W	D	H	AH	SH
20	22	31		19.75
COM YDS	COL SQ. FT.	CU. FT.	QTY/CT	LBS.
		14.2	2	45

ash wood side chair-wood seat and back



Bar Stool-Upholstered Seat and Back
CRISS CROSS-3

W	D	H	AH	SH
18	19.25	40		30.5
COM YDS	COL SQ. FT.	CU. FT.	QTY/CT	LBS.
1	17	11	1	30

ash wood bar stool-tight seat and back-wood out back-metal foot rail



**Bar Stool-Wood Seat and Back
CRISS CROSS-4**

W	D	H	AH	SH
18	19.25	40		30.5
COM YDS	COL SQ. FT.	CU. FT.	QTY/CT	LBS.
		11	1	30

ash wood bar stool-wood seat and back-metal foot rail



**Occasional Chair
DANA**

W	D	H	AH	SH
30	29	31	25	18
COM YDS	COL SQ. FT.	CU. FT.	QTY/CT	LBS.
3.5	63	11.75	1	39



occasional chair-steel frame with molded cold-cured polyurethane foam shell-black powder coated metal legs (FG-Black)-top stitched

NOTE: FABRICS MUST BE APPROVED FOR APPLICATION-STRETCH REQUIRED (shown in Ultrafabrics)-minimum quantity required: 2



**Pedestal Chair
DANNY-D1**

W	D	H	AH	SH
25	21.75	29.75	23.75	19
COM YDS	COL SQ. FT.	CU. FT.	QTY/CT	LBS.
1.75	29.75	11.29	1	60.39

arm chair-rigid polyurethane cold cured shell-stainless steel-base-swivel with return-top and/or single stitched based onCOM-KD-assembly required-2 cartons-minimum quantity required: 10



**Arm Chair
DANNY-L7**

W	D	H	AH	SH
25	21.75	29.75	23.75	19.00

COM YDS	COL SQ. FT.	CU. FT.	QTY/CT	LBS.
1.75	29.75	11.29	1	60.39

arm chair-rigid polyurethane cold cured shell-beech wood legs-top and/or single stitched based on COM-KD-assembly required-2 cartons-minimum quantity required: 10



**Arm Chair
DANNY-P4**

W	D	H	AH	SH
25.00	21.75	29.75	23.75	19
COM YDS	COL SQ. FT.	CU. FT.	QTY/CT	LBS.
1.75	29.75	10.29	1	29.24

arm chair-steel frame with molded cold-cured polyurethane shell-polished chrome-top and/or single stitched based on COM-minimum quantity required: 10



**Pedestal Chair
DANNY-R1**

W	D	H	AH	SH
25	21.75	29.75	23.75	19
COM YDS	COL SQ. FT.	CU. FT.	QTY/CT	LBS.
1.75	29.75	11.29	1	43.86

arm chair-rigid polyurethane cold cured shell-polished chrome
base-swivel-top and/or single stitched based on COM-KD-assembly
required-2 cartons-minimum quantity required: 10



**Task Chair
DANNY-R10**

W	D	H	AH	SH
25	21.75	29-32	23-26	18-21

COM YDS	COL SQ. FT.	CU. FT.	QTY/CT	LBS.
1.75	29.75	12	1	37.24

task chair-rigid polyurethane cold cured shell-base-die cast aluminum-polished chrome-high resistance steel tube-gas lift-swivel-top and/or single stitched based on COM-KD-assembly required-2 cartons-minimum quantity required: 10



**Arm Chair
DANNY-SS**

W	D	H	AH	SH
25	21.75	29.50	23.75	18.50
COM YDS	COL SQ. FT.	CU. FT.	QTY/CT	LBS.
1.75	29.75	10.21	1	29.24

arm chair-steel frame with molded cold-cured polyurethane shell-polished chrome-top and/or single stitched based on COM-minimum quantity required: 10



**Bar Stool
DANTE**

W	D	H	AH	SH
18.25	20.25	45		30.25
COM YDS	COL SQ. FT.	CU. FT.	QTY/CT	LBS.
		12	1	26

beech wood bar stool-all wood seat and back-metal foot rail-upholstery options available for seat and back



Side Chair
DANTE

W	D	H	AH	SH
21.75	20.50	31.75		18
COM YDS	COL SQ. FT.	CU. FT.	QTY/CT	LBS.
		11	1	18

beech wood side chair-all wood seat and back-upholstery options available for seat and back





Bar Stool-Metal
DANTE

W	D	H	AH	SH
18.25	20.25	45		30.25
COM YDS	COL SQ. FT.	CU. FT.	QTY/CT	LBS.
		12	1	26

beech wood bar stool-all wood seat and back-black metal legs/base
(ML 03)-upholstery options available for seat and back-black metal
foot rail



Side Chair-Metal
DANTE

W	D	H	AH	SH
21.75	20.50	31.75		18
COM YDS	COL SQ. FT.	CU. FT.	QTY/CT	LBS.
		11	1	18

beech wood side chair-all wood seat and back-black metal legs/base
(ML 03)-upholstery options available for seat and back





Side Chair
DAVID

W	D	H	AH	SH
19	22	32		19
COM YDS	COL SQ. FT.	CU. FT.	QTY/CT	LBS.
1.25	22.5	12.3	2	28

beech wood side chair-tight seat and back-wood out/back-welt at in/back top only





**Occasional Chair
EMMA**

W	D	H	AH	SH
30	30	29.5	21.75	18
COM YDS	COL SQ. FT.	CU. FT.	QTY/CT	LBS.
3	54	13.25	1	35

occasional chair-steel frame with molded cold-cured polyurethane foam shell-black powder coated metal legs (FG-Black)-top stitched

NOTE: FABRICS MUST BE APPROVED FOR APPLICATION-STRETCH REQUIRED (shown in Ultrafabrics)-minimum quantity required: 2





**Arm Chair
ESPIRITO**

W	D	H	AH	SH
23.5	23.5	34	27	19
COM YDS	COL SQ. FT.	CU. FT.	QTY/CT	LBS.
1.5	25.5	16.5	1	22

beech wood arm chair-tight seat and back-welt at in back



**Bar Stool
ESPIRITO**

W	D	H	AH	SH
21	22.25	41.25		31
COM YDS	COL SQ. FT.	CU. FT.	QTY/CT	LBS.
1.25	21.25	11	1	20

beech wood bar stool-tight seat and back-welt at in back-metal foot rail





**Occasional Chair
ESPIRITO**

W	D	H	AH	SH
28	23.5	32.25	25.5	18
COM YDS	COL SQ. FT.	CU. FT.	QTY/CT	LBS.
2.5	42.5	16.24	1	25

beech wood occasional chair-tight seat and back-welt at in back





Side Chair
ESPIRITO

W	D	H	AH	SH
19.5	23	34		19
COM YDS	COL SQ. FT.	CU. FT.	QTY/CT	LBS.
1.5	25.5	14.25	1	20

beech wood side chair-tight seat and back-welt at in back



**Pedestal Chair
FALLON**

W	D	H	AH	SH
30.5	30.5	45	23.5	17
COM YDS	COL SQ. FT.	CU. FT.	QTY/CT	LBS.
3.5	63	27	1	46.5

pedestal lounge chair-swivel-steel frame seat shell with rigid polyurethane cold cured foam-standard in polished chrome (ML 00) or black powder coat (ML 03)-top and double needle stitched based on COM-ships KD-assembly required-2 cartons

NOTE: FABRIC MUST BE APPROVED FOR APPLICATION-4 WAY STRETCH REQUIRED-minimum quantity required: 4-zipper or seams on sides may be required based on fabric-multiple base options available





**Lounge Chair
FALLON-14**

W	D	H	AH	SH
30.5	30.5	44	23	17
COM YDS	COL SQ. FT.	CU. FT.	QTY/CT	LBS.
3.5	63	27	1	37.5

lounge chair-beech wood legs/base-steel frame seat shell with rigid polyurethane cold cured foam-top and/or double needle stitched based on COM

NOTE: FABRIC MUST BE APPROVED FOR APPLICATION-4 WAY STRETCH REQUIRED-minimum quantity required: 4-zipper or seams on side may be required based on COM-multiple base options available



**Lounge Chair
FALLON-31**

W	D	H	AH	SH
30.5	30.5	44	23	17
COM YDS	COL SQ. FT.	CU. FT.	QTY/CT	LBS.
3.5	63	27	1	40



lounge chair-beech wood base/legs-steel frame seat shell with rigid polyurethane cold cured foam-top and double needle stitched based on COM-minimum quantity required: 4

NOTE: FABRIC MUST BE APPROVED FOR APPLICATION-4 WAY STRETCH REQUIRED-zipper or seams on sides may be required based on fabric-multiple base options available



**Bar Stool
FRIDAY-SG-SI**

W	D	H	AH	SH
20	21	41		31

COM YDS	COL SQ. FT.	CU. FT.	QTY/CT	LBS.
0.5	8.5	14.13	1	25

beech wood bar stool with tight seat and wood back-no welt-metal foot rail



Bar Stool
FRIDAY-SG-SI-SPECIAL

W	D	H	AH	SH
20	21	41		31

COM YDS	COL SQ. FT.	CU. FT.	QTY/CT	LBS.
.75	12.75	14.13	1	25

beech wood bar stool with tight seat and upholstered in-back-no welt-metal foot rail



Bar Stool
FRIDAY-SG-SL

W	D	H	AH	SH
20	21	41		31
COM YDS	COL SQ. FT.	CU. FT.	QTY/CT	LBS.
		14.13	1	25

beech wood bar stool with wood seat and wood back-metal foot rail



Side Chair
FRIDAY-SI-STACKING

W	D	H	AH	SH
20	21.25	31.5		18.5

COM YDS	COL SQ. FT.	CU. FT.	QTY/CT	LBS.
0.5	8.5	13.42	2	35

beech wood side chair with tight seat and wood back-no welt-
stacking-4



Side Chair
FRIDAY-SI-SPECIAL-STACKING

W	D	H	AH	SH
20	21.25	31.5		18.5

COM YDS	COL SQ. FT.	CU. FT.	QTY/CT	LBS.
0.75	12.75	13.42	2	35

beech wood side chair with tight seat and upholstered in-back-no welt-stacking-4



Side Chair
FRIDAY-SL-STACKING

W	D	H	AH	SH
20	21.25	31.5		18.5
COM YDS	COL SQ. FT.	CU. FT.	QTY/CT	LBS.
		13.42	2	35

beech wood side chair with wood seat and back-stacking-4



**Arm Chair
FULLY-P**

W	D	H	AH	SH
18	20	33.5	27	18.5
COM YDS	COL SQ. FT.	CU. FT.	QTY/CT	LBS.
1.5	25.5	18.36	1	26

beech wood arm chair with tight seat and back



Side Chair
FULLY

W	D	H	AH	SH
18	19.5	33.25		18.5
COM YDS	COL SQ. FT.	CU. FT.	QTY/CT	LBS.
1.25	21.25	10.59	2	33

beech wood side chair with tight seat and back-top and/or single stitched based on COM





**Bar Stool
FULLY-SG**

W	D	H	AH	SH
16	19.25	39.25		30
COM YDS	COL SQ. FT.	CU. FT.	QTY/CT	LBS.
1.25	21.25	9.89	1	24

beech wood bar stool with tight seat and back-top and/or single stitched based on COM-black nylon foot rail





Lounge Chair
FULLY-L

W	D	H	AH	SH
27.50	29	31	24	18
COM YDS	COL SQ. FT.	CU. FT.	QTY/CT	LBS.
3.50	59.50	15.54	1	39.68

beech wood lounge chair with loose seat and self deck-top and/or single stitched based on COM-welt





Sofa
FULLY SOFA

W	D	H	AH	SH
52	29	31	24	18
COM YDS	COL SQ. FT.	CU. FT.	QTY/CT	LBS.
6.50	110.50	28.61	1	69.45

beech wood sofa with loose seat and self deck-top and/or single stitched based on COM-welt





**Lounge Chair
GABRIEL**

W	D	H	AH	SH
28.5	33.5	40	23.5	18
COM YDS	COL SQ. FT.	CU. FT.	QTY/CT	LBS.
4	72	17.25	1	43

lounge chair-steel frame with molded cold-cured polyurethane foam shell-black powder coated metal legs (FG-Black)-top stitched and double needle stitched

NOTE: FABRICS MUST BE APPROVED FOR APPLICATION-STRETCH REQUIRED (shown in Ultrafabrics)-minimum quantity required: 2





Side Chair
GIPSY-S

W	D	H	AH	SH
24	21.25	32.25	24.50	18.50
COM YDS	COL SQ. FT.	CU. FT.	QTY/CT	LBS.
2	34	12.36	1	31.00

beech wood side chair-tight back and seat-no welt-top and/or single stitched based on COM





**Bar Stool
GIPSY-SG**

W	D	H	AH	SH
21	21.75	41		31.00
COM YDS	COL SQ. FT.	CU. FT.	QTY/CT	LBS.
1.50	25.50	10.59	1	33.50

beech wood bar stool-tight back and seat-chrome foot rail-no welt-top and/or single stitched based on COM





Occasional Chair
GIPSY-XL

W	D	H	AH	SH
27	27.75	34.75		16.5
COM YDS	COL SQ. FT.	CU. FT.	QTY/CT	LBS.
3	51	17.66	1	33

beech wood occasional chair with tight seat and back-no welt-top and/or single stitched based on COM



**Arm Chair
GROTTO**

W	D	H	AH	SH
22.25	21	32	26	18.75
COM YDS	COL SQ. FT.	CU. FT.	QTY/CT	LBS.
2	34	11.65	1	27

beech wood arm chair-tight seat and back-no welt-top and/or single stitched based on COM-in back and out back seams-multiple base options available



**Side Chair
GROTTO**

W	D	H	AH	SH
22.25	21	32		18.75
COM YDS	COL SQ. FT.	CU. FT.	QTY/CT	LBS.
2	34	11.65	1	25

beech wood side chair-tight seat and back-no welt-top and/or single stitched based on COM-in back and out back seams-multiple base options available



**Bar Stool
GROTTO-SG-SCL**

W	D	H	AH	SH
22.25	21	45.5		31.75
COM YDS	COL SQ. FT.	CU. FT.	QTY/CT	LBS.
2	34	14.13	1	35

beech wood bar stool-tight seat and back-no welt-top and/or single stitched based on COM-in back and out back seams-metal foot rail-multiple base options available



Bar Stool
GROTTO-SG-SCL-ARMS

W	D	H	AH	SH
22.5	21	45.5	40	31.75
COM YDS	COL SQ. FT.	CU. FT.	QTY/CT	LBS.
2.5	42.5	14.13	1	35

beech wood bar stool-arm-tight seat and back-no welt-top and/or single stitched based on COM-in back and out back seams-metal foot rail-multiple base options available



**Arm Chair-Metal
HANA**

W	D	H	AH	SH
21.50	21.25	33.50	24	18.50
COM YDS	COL SQ. FT.	CU. FT.	QTY/CT	LBS.
2	36	12	1	21

bent wood arm chair with black metal legs/base (ML 03)-tight seat and back-welt at in back-top and/or single stitched based on COM

NOTE: FABRICS MUST BE APPROVED FOR APPLICATION-4 WAY STRETCH REQUIRED





**Bar Stool-Metal
HANA**

W	D	H	AH	SH
21.50	21.25	44.50	35	30
COM YDS	COL SQ. FT.	CU. FT.	QTY/CT	LBS.
2	36	14	1	24

bent wood bar stool with black metal legs/base (ML 03)-tight seat and back-welt at in back-top and/or single stitched based on COM-black metal foot rail

NOTE: FABRICS MUST BE APPROVED FOR APPLICATION-4 WAY STRETCH REQUIRED



Occasional Chair
HOMER

W	D	H	AH	SH
28.50	30	37	27.50	18
COM YDS	COL SQ. FT.	CU. FT.	QTY/CT	LBS.
4	73	22	1	44

beech wood occasional chair-tight seat and back-welt at arm and top stitched

NOTE: FABRICS MUST BE APPROVED FOR APPLICATION-4 WAY STRETCH REQUIRED





**Arm Chair
IMPALA**

W	D	H	AH	SH
25.25	26.5	34.5	25	19

COM YDS	COL SQ. FT.	CU. FT.	QTY/CT	LBS.
3.25	55.25	14.13	1	27

beech wood arm chair with tight seat and back-no welt-top and/or single stitched based on COM



**Arm Chair
IDUSTRIALE**

W	D	H	AH	SH
24.5	24.5	32.75	25.5	18
COM YDS	COL SQ. FT.	CU. FT.	QTY/CT	LBS.
1.75	31	13	1	18

arm chair-black powder coated metal frame (ML 03) with upholstered seat and in back-no welt-top stitched-exposed beech wood arm caps-minimum quantity required: 10





**Curved Bench
ISOLANO**

W	D	H	AH	SH
88	28	33.25		18
COM YDS	COL SQ. FT.	CU. FT.	QTY/CT	LBS.
6.5	117	46	1	126



curved bench with satin stainless steel base/legs (M1-SS-satin) and special anti-corrosive protective top coat-no welt-double needle seat/top stitch back-NOTE: overall depth with the curve is 40"-minimum quantity required: 2



**Occasional Chair
JAMES**

W	D	H	AH	SH
30	30.5	32.75	23.75	18
COM YDS	COL SQ. FT.	CU. FT.	QTY/CT	LBS.
3.5	63	13.25	1	43



occasional chair-steel frame with molded cold-cured polyurethane foam shell-black powder coated metal legs (FG-Black)-top stitched

NOTE: FABRICS MUST BE APPROVED FOR APPLICATION-STRETCH REQUIRED (shown in Ultrafabrics)-minimum quantity required: 2



**Loveseat
JAMES**

W	D	H	AH	SH
55	31	32.75	22.25	18
COM YDS	COL SQ. FT.	CU. FT.	QTY/CT	LBS.
5	90	25.75	1	93



loveseat-steel frame with molded cold-cured polyurethane shell foam-black powder coated metal legs (FG-Black)-top stitched

NOTE: FABRICS MUST BE APPROVED FOR APPLICATION-STRETCH REQUIRED (shown in Ultrafabrics)



Side Chair
JAMIE

W	D	H	AH	SH
19	21	31		18.75
COM YDS	COL SQ. FT.	CU. FT.	QTY/CT	LBS.
1.50	27	9	1	17

bent wood side chair with beech wood legs/base-tight seat and back-top and/or single stitched based on COM





**Bar Stool
JAMIE**

W	D	H	AH	SH
19	21	42		30

COM YDS	COL SQ. FT.	CU. FT.	QTY/CT	LBS.
1.50	27	13	1	21

bent wood bar stool with beech wood legs/base-tight seat and back-top and/or single stitched based on COM-black metal foot rail



Bar Stool-Metal
JAMIE

W	D	H	AH	SH
18.50	21	42		30

COM YDS	COL SQ. FT.	CU. FT.	QTY/CT	LBS.
1.50	27	13	1	22

bent wood bar stool with black metal legs/base (ML 03)-tight seat and back-top and/or single stitched based on COM-black metal foot rail



Side Chair-Metal
JAMIE

W	D	H	AH	SH
18.50	21	31		18.50
COM YDS	COL SQ. FT.	CU. FT.	QTY/CT	LBS.
1.50	27	9	1	19

bent wood side chair with black metal legs/base (ML 03) -tight seat and back-top and/or single stitched based on COM





**Arm Chair
JERRY**

W	D	H	AH	SH
22	23	33	26	19
COM YDS	COL SQ. FT.	CU. FT.	QTY/CT	LBS.
1.5	27	11.65	1	23

beech wood arm chair-tight seat and back-no welt-top and/or single stitched based on COM





Side Chair
JERRY

W	D	H	AH	SH
19	23	33		19
COM YDS	COL SQ. FT.	CU. FT.	QTY/CT	LBS.
1.5	27	13.7	2	40

beech wood side chair-tight seat and back-no welt-top and/or single stitched based on COM





Bar Stool
JERRY

W	D	H	AH	SH
18.5	21.5	42.5		31
COM YDS	COL SQ. FT.	CU. FT.	QTY/CT	LBS.
1.5	27	11.65	1	28

beech wood-bar stool-tight seat and back-no welt-top and/or single stitched based on COM-stainless steel metal foot rail





**Pedestal Chair
KAREN-D1**

W	D	H	AH	SH
25	23.50	36.25	25.50	18
COM YDS	COL SQ. FT.	CU. FT.	QTY/CT	LBS.
1.75	28	14.23	1	55.98

arm chair-steel frame with molded cold-cured polyurethane shell-stainless steel-swivel-top and/or single stitched based on COM-KD-assembly required-2 cartons

NOTE: FABRICS MUST BE APPROVED FOR APPLICATION-4 WAY STRETCH REQUIRED-minimum quantity required: 10



**Arm Chair
KAREN-L7**

W	D	H	AH	SH
25	23.50	36.25	25.50	18.00

COM YDS	COL SQ. FT.	CU. FT.	QTY/CT	LBS.
1.75	28	13.23	1	24.84

arm chair-steel frame with molded cold-cured polyurethane shell-
beech wood legs-top and/or single stitched based on COM-KD-as-
sembly required

NOTE: FABRICS MUST BE APPROVED FOR APPLICATION-4 WAY
STRETCH REQUIRED-minimum quantity required: 10



**Pedestal Chair
KAREN-R1**

W	D	H	AH	SH
25	23.50	36.25	25.50	18

COM YDS	COL SQ. FT.	CU. FT.	QTY/CT	LBS.
1.75	28	13.23	1	34.45

arm chair-steel frame with molded cold-cured polyurethane shell-
base-die cast aluminum-polished chrome-high resistance steel
tube-swivel-top and/or single stitched based on COM-KD-assembly
required-2 cartons

NOTE: FABRICS MUST BE APPROVED FOR APPLICATION-4 WAY
STRETCH REQUIRED-minimum quantity required: 10



**Task Chair
KAREN-R9**

W	D	H	AH	SH
25	23.50	32-35	25-28	17-20

COM YDS	COL SQ. FT.	CU. FT.	QTY/CT	LBS.
1.75	28	13	1	33.94

arm chair-steel frame with molded cold-cured polyurethane shell-
chrome base-swivel-gas lift-top and/or single stitched based on
COM-KD-assembly required-2 cartons

NOTE: FABRICS MUST BE APPROVED FOR APPLICATION-4 WAY
STRETCH REQUIRED-minimum quantity required: 10



**Arm Chair
KAREN-S5**

W	D	H	AH	SH
25	23.50	36.25	25.50	18
COM YDS	COL SQ. FT.	CU. FT.	QTY/CT	LBS.
1.75	28	13.23	1	24.84

arm chair-steel frame with molded cold-cured polyurethane shell-polished chrome legs-top and/or single stitched based on COM

NOTE: FABRICS MUST BE APPROVED FOR APPLICATION-4 WAY STRETCH REQUIRED-minimum quantity required: 10



Side Chair
KRAMER

W	D	H	AH	SH
20.50	23.75	32.75		19
COM YDS	COL SQ. FT.	CU. FT.	QTY/CT	LBS.
1.75	31.5	13.40	2	42

beech wood side chair-tight seat and back-no welt





**Side Chair
KSENIA-I**

W	D	H	AH	SH
21.75	21.75	29.75		19.50

COM YDS	COL SQ. FT.	CU. FT.	QTY/CT	LBS.
1	17	13.42	2	37.48

beech wood side chair with tight seat and in back-wood out back-no welt





Lounge Chair
KSENIA-LOUNGE

W	D	H	AH	SH
28.75	27.75	29.50		17.00
COM YDS	COL SQ. FT.	CU. FT.	QTY/CT	LBS.
1.75	29.75	15.89	1	28.66

beech wood lounge chair with tight seat and in back-wood out back-no welt





Side Chair
KSENIA-WOOD

W	D	H	AH	SH
20	21.25	29.75		18.00
COM YDS	COL SQ. FT.	CU. FT.	QTY/CT	LBS.
		12.36	2	30.86

beech wood side chair without upholstery





**Bar Stool
KSENIA-1-SG**

W	D	H	AH	SH
19.5	19.75	41.25		31

COM YDS	COL SQ. FT.	CU. FT.	QTY/CT	LBS.
1	17	9.18	1	23.5

beech wood bar stool with upholstered tight seat and in back-wood
out back-black nylon foot rail-no welt



Bar Stool
KSENIA-SG-WOOD

W	D	H	AH	SH
19.5	19.75	41.25		30
COM YDS	COL SQ. FT.	CU. FT.	QTY/CT	LBS.
		9.18	1	23.00

beech wood bar stool with an all wood frame-black nylon foot rail



Side Chair-Metal
LENO

W	D	H	AH	SH
21.5	22.5	33		19
COM YDS	COL SQ. FT.	CU. FT.	QTY/CT	LBS.
1.5	27	11.65	1	25

bent wood seat shell side chair-black powder coated metal frame (ML 03) standard-other colors available with minimum order/up-charge-tight seat and back-welt at in/back top-top and/or single stitched based on COM





Bar Stool-Metal
LENO

W	D	H	AH	SH
21.50	22	42		30
COM YDS	COL SQ. FT.	CU. FT.	QTY/CT	LBS.
1.5	27	13.5	1	30

bent wood seat shell bar stool-black powder coated metal frame (ML 03) standard-other colors available with minimum order/up-charge-tight seat and back-welt at in/back top-top and/or single stitched based on COM





Side Chair
LEWIS SE-01

W	D	H	AH	SH
21.5	25	35.5		19
COM YDS	COL SQ. FT.	CU. FT.	QTY/CT	LBS.
2	28	14.13	1	24.5

bent wood seat shell-side chair-beech wood legs/base-loose seat and tight back-no welt-top and/or single stitched based on COM-seam placement is based on fabric-multiple base options available





Side Chair
LEWIS SE-01-20

W	D	H	AH	SH
21.5	25	35.5	0	19
COM YDS	COL SQ. FT.	CU. FT.	QTY/CT	LBS.
2	28	14.13	1	22

bent wood seat shell-side chair-polished chrome (ML-00) or black legs (ML-03) standard-other colors available with minimum order/up-charge-loose seat and tight back-no welt-top and/or single stitched based on COM-seams placement is based on fabric-multiple base options available





**Occasional Chair
LEWIS PL-01**

W	D	H	AH	SH
28.5	29	32.5	22	17
COM YDS	COL SQ. FT.	CU. FT.	QTY/CT	LBS.
3.5	48	19.07	1	41



bent wood seat shell-occasional chair-beech wood base/legs-tight seat and back-no welt-top and/or single stitched based on COM

NOTE: FABRIC MUST BE APPROVED FOR APPLICATION-4 WAY STRETCH REQUIRED-zipper or seams on sides may be required based on fabric-multiple base options available



**Pedestal Chair
LEWIS PL-01-24**

W	D	H	AH	SH
28.5	29	32.5	22	17
COM YDS	COL SQ. FT.	CU. FT.	QTY/CT	LBS.
3.5	48	19.07	1	49

bent wood seat shell-pedestal lounge chair-swivel-black base (M6) standard-other colors available with minimum order/upcharge-tight seat and back-no welt-top and/or single stitched based on COM

NOTE: FABRIC MUST BE APPROVED FOR APPLICATION-4 WAY STRETCH REQUIRED-zipper or seams on sides may be required based on fabric-multiple base options available





**Bar Stool
LOLA**

W	D	H	AH	SH
19	21	42		30
COM YDS	COL SQ. FT.	CU. FT.	QTY/CT	LBS.
1.50	27	13	1	19

bent wood bar stool with beech wood legs/base-tight seat and back-welt at in back -top and/or single stitched based on COM-black metal foot rail

NOTE: FABRICS MUST BE APPROVED FOR APPLICATION-4 WAY STRETCH REQUIRED



Side Chair
LOLA

W	D	H	AH	SH
19	21	31		18.75
COM YDS	COL SQ. FT.	CU. FT.	QTY/CT	LBS.
1.50	27	9	1	15

bent wood side chair with beech wood legs/base -tight seat and back-welt at in back -top and/or single stitched based on COM

NOTE: FABRICS MUST BE APPROVED FOR APPLICATION-4 WAY STRETCH REQUIRED





**Bar Stool-Metal
LOLA**

W	D	H	AH	SH
18.50	21	42		30
COM YDS	COL SQ. FT.	CU. FT.	QTY/CT	LBS.
1.50	27	13	1	20

bent wood bar stool with black metal legs/base (ML 03)-tight seat and back-welt at in back-top and/or single stitched based on COM-black metal foot rail

NOTE: FABRICS MUST BE APPROVED FOR APPLICATION-4 WAY STRETCH REQUIRED



Side Chair-Metal
LOLA

W	D	H	AH	SH
18.50	21	31		18.50
COM YDS	COL SQ. FT.	CU. FT.	QTY/CT	LBS.
1.50	27	9	1	17

bent wood side chair with black metal legs/base (ML 03)-tight seat and back-welt at in back-top and/or single stitched based on COM

NOTE: FABRICS MUST BE APPROVED FOR APPLICATION-4 WAY STRETCH REQUIRED





**Lounge Chair
LUCAS**

W	D	H	AH	SH
35.5	31	31.5	31.5	18
COM YDS	COL SQ. FT.	CU. FT.	QTY/CT	LBS.
3.5	63	16.75	1	54

lounge chair-steel frame with molded cold-cured polyurethane foam shell-black powder coated metal legs (FG-Black)-top stitched

NOTE: FABRICS MUST BE APPROVED FOR APPLICATION-STRETCH REQUIRED (shown in Ultrafabrics)-minimum quantity required: 2





**Arm Chair-Metal Base
LUNA-P**

W	D	H	AH	SH
24.5	24.5	32	24.75	18
COM YDS	COL SQ. FT.	CU. FT.	QTY/CT	LBS.
3	51	17.66	1	21

arm chair-steel frame with molded cold-cured polyurethane shell-metal base / legs-choice of FG brushed aluminum, black or white finishes-top and/or single stitched based on COM-no welt

NOTE: FABRICS MUST BE APPROVED FOR APPLICATION-4 WAY STRETCH REQUIRED-minimum quantity required: 10





**Side Chair-Metal Base
LUNA-S**

W	D	H	AH	SH
20.25	23.75	32		18
COM YDS	COL SQ. FT.	CU. FT.	QTY/CT	LBS.
2.5	42.5	17.66	1	19

side chair-steel frame with molded cold-cured polyurethane shell-metal base / legs-choice of FG brushed aluminum, black or white finishes-top and/or single stitched based on COM-no welt

NOTE: FABRICS MUST BE APPROVED FOR APPLICATION-4 WAY STRETCH REQUIRED-minimum quantity required: 10



**Arm Chair
MADRE**

W	D	H	AH	SH
22	26.5	31.5	26	19
COM YDS	COL SQ. FT.	CU. FT.	QTY/CT	LBS.
2.25	38.25	14	1	26

beech wood arm chair-tight seat and back-no welt-top and/or single stitched based on COM



**Bar Stool
MADRE**

W	D	H	AH	SH
20	22	43		31.5

COM YDS	COL SQ. FT.	CU. FT.	QTY/CT	LBS.
1.75	29.75	11	1	24

beech wood bar stool-tight seat and back-no welt-top and/or single stitched based on COM-polished chrome foot rail



**Loveseat
MADRE**

W	D	H	AH	SH
44	28.5	30.5		17.5
COM YDS	COL SQ. FT.	CU. FT.	QTY/CT	LBS.
5	85	31	1	50

beech wood loveseat-tight seat and back-no welt-top and/or single stitched based on COM



**Occasional Chair-Swivel
MADRE**

W	D	H	AH	SH
24	29	30.5		17.5
COM YDS	COL SQ. FT.	CU. FT.	QTY/CT	LBS.
3	51	15.5	1	35

beech wood occasional chair-tight seat and back-no welt-top and/or single stitched based on COM-swivel



Ottoman
MADRE

W	D	H	AH	SH
17.75	17.75	19		19
COM YDS	COL SQ. FT.	CU. FT.	QTY/CT	LBS.
1	17	16	2	28

beech wood ottoman-tight seat-no welt



Side Chair
MADRE

W	D	H	AH	SH
21.5	26	34		19
COM YDS	COL SQ. FT.	CU. FT.	QTY/CT	LBS.
2	34	14	1	25

beech wood side chair-tight seat and back-no welt-top and/or single stitched based on COM



**Arm Chair-Metal
MATTHEW**

W	D	H	AH	SH
23	24	31.50	27	19
COM YDS	COL SQ. FT.	CU. FT.	QTY/CT	LBS.
3	54	14.25	1	44

bent wood arm chair-tight seat and back-no welt-top and/or single stitched based on COM-powder coated metal base/legs in black (ML 03), white (FG White) and grey (TL-Grey)





Side Chair
MAYATA

W	D	H	AH	SH
19	22.50	34		19.00
COM YDS	COL SQ. FT.	CU. FT.	QTY/CT	LBS.
1.25	21.25	11.65	2	37.48

beech wood side chair with tight seat and back-no welt-single stitch-minimum order required with stretcher (as shown above)

MAYATA-STANDARD
(no stretcher-no minimum order required)





**Arm Chair
MAYATA-P**

W	D	H	AH	SH
22.50	22.50	34	24.50	19.00
COM YDS	COL SQ. FT.	CU. FT.	QTY/CT	LBS.
1.25	21.25	11.65	1	24.25

beech wood arm chair with tight seat and back-no welt





**Lounge Chair
MILANO**

W	D	H	AH	SH
27.5	31.5	31		17
COM YDS	COL SQ. FT.	CU. FT.	QTY/CT	LBS.
2.25	40	18.5	1	42

lounge chair with satin stainless steel out back frame/base/legs (M1-SS-satin) and special anti-corrosive protective top coat-channel foam pattern-top stitched-minimum quantity required: 2





**Arm Chair
MIRA**

W	D	H	AH	SH
22.5	23.5	30.5	26	18.75
COM YDS	COL SQ. FT.	CU. FT.	QTY/CT	LBS.
1	17	12.01	1	20

beech wood arm chair-tight seat and back-wood out back-no welt



Side Chair
MIRA

W	D	H	AH	SH
19	21	30.5		18.75
COM YDS	COL SQ. FT.	CU. FT.	QTY/CT	LBS.
1	17	10.95	2	34

beech wood side chair-tight seat and back-wood out back-no welt



**Arm Chair
NANCE**

W	D	H	AH	SH
21.5	22.5	33.5	25.75	19
COM YDS	COL SQ. FT.	CU. FT.	QTY/CT	LBS.
2.5	42.5	12.36	1	24.25

beech wood arm chair-tight seat and back-top stitched



Side Chair
NANCE

W	D	H	AH	SH
20	21.5	33.5		19
COM YDS	COL SQ. FT.	CU. FT.	QTY/CT	LBS.
1.75	29.75	12.36	2	44.25

beech wood side chair-tight seat and back-top stitched



**Arm Chair
NICKY**

W	D	H	AH	SH
19.5	20.25	32		18.25
COM YDS	COL SQ. FT.	CU. FT.	QTY/CT	LBS.
1.25	21.25	10.95	1	23.5

arm chair-steel frame-tight seat and back-no welt-top and/or single stitched based on COM-choice of frame colors-see finish chart (ML 01, ML 02, ML 03)





**Bar Stool
NICKY**

W	D	H	AH	SH
20.25	21	42.5		29
COM YDS	COL SQ. FT.	CU. FT.	QTY/CT	LBS.
1.25	21.25	13.07	1	21.25

bar stool-steel frame-tight seat and back-no welt-top and/or single stitched based on COM-choice of frame colors-see finish chart (ML 01, ML 02, ML 03)



Occasional Chair
NICKY

W	D	H	AH	SH
24	20.25	29		15
COM YDS	COL SQ. FT.	CU. FT.	QTY/CT	LBS.
1.5	25.5	10.59	1	23.25

occasional chair-steel frame-tight seat and back-no welt-top and/or single stitched based on COM-choice of frame colors-see finish chart (ML 01, ML 02, ML 03)





**Side Chair
NICKY**

W	D	H	AH	SH
19.5	20.25	32		18.25
COM YDS	COL SQ. FT.	CU. FT.	QTY/CT	LBS.
1.25	18	10.59	1	21

side chair-steel frame-tight seat and back-no welt-top and/or single stitched based on COM-choice of frame colors-see finish chart (ML 01, ML 02, ML 03)





**Arm Chair
NINA**

W	D	H	AH	SH
22	21.50	32	26	18.50
COM YDS	COL SQ. FT.	CU. FT.	QTY/CT	LBS.
2	36	12	1	19

beech wood arm chair with tight seat and back-welt under back-top and/or single stitched based on COM





**Side Chair
NOBLE-223**

W	D	H	AH	SH
19	23	34		19
COM YDS	COL SQ. FT.	CU. FT.	QTY/CT	LBS.
2.5	42.5	13.77	2	45

beech wood side chair with tight seat and back-top stitch seat-in/out back welt





**Bar Stool
NOBLE-226**

W	D	H	AH	SH
20	24	41		32
COM YDS	COL SQ. FT.	CU. FT.	QTY/CT	LBS.
2	34	15.22	1	30

beech wood bar stool with tight seat and back-top stitch seat-in/out
back welt-metal foot rail





Occasional Chair
NOBLE-228

W	D	H	AH	SH
25	27	33		19
COM YDS	COL SQ. FT.	CU. FT.	QTY/CT	LBS.
2	34	18.61	1	32

beech wood occasional chair with tight seat and back-top stitch seat-in/out back welt





**Loveseat
NOBLE-234**

W	D	H	AH	SH
48	27	33		19

COM YDS	COL SQ. FT.	CU. FT.	QTY/CT	LBS.
5.5	93.5	33.20	1	53

beech wood loveseat with tight seat and back-top stitch seat-in/out back welt





Side Chair
NOEL

W	D	H	AH	SH
19.5	23	32.5		18.25
COM YDS	COL SQ. FT.	CU. FT.	QTY/CT	LBS.
1.75	29.75	12.36	2	44.25

beech wood side chair-tight seat and back-no welt-top and/or single stitched based on COM



**Bar Stool
NOEL-SG**

W	D	H	AH	SH
19	21.75	45.5		30.75
COM YDS	COL SQ. FT.	CU. FT.	QTY/CT	LBS.
1.75	29.75	13.42	1	22.25

beech wood bar stool-tight seat and back-no welt-top and/or single stitched based on COM-metal foot rail





Lounge Chair
ODYSSEY

W	D	H	AH	SH
28	32.50	38.50		18
COM YDS	COL SQ. FT.	CU. FT.	QTY/CT	LBS.
4.25	80	20	1	35.50

beech wood lounge chair-tight seat and back-welt at out-back





Side Chair
OLIVER

W	D	H	AH	SH
18.25	21.75	33.25		18.50
COM YDS	COL SQ. FT.	CU. FT.	QTY/CT	LBS.
1.25	22.5	10	1	22.7

side chair-steel frame seat shell with rigid polyurethane cold cured foam-beech wood base/legs-top and/or single stitched based on COM

NOTE: FABRIC MUST BE APPROVED FOR APPLICATION-4 WAY STRETCH REQUIRED-minimum quantity required: 10-multiple base options available





Side Chair-Swivel
OLIVER

W	D	H	AH	SH
18.25	21.75	32.75		18.50
COM YDS	COL SQ. FT.	CU. FT.	QTY/CT	LBS.
1.25	22.5	10	1	27.11

swivel side chair-rigid polyurethane cold cured seat shell-beech wood base/legs-top and/or single stitched based on COM

NOTE: FABRICS MUST BE APPROVED FOR APPLICATION-4 WAY STRETCH REQUIRED-minimum quantity required: 10-multiple base options available



**Task Chair
OLIVER**

W	D	H	AH	SH
18	21.75	32.5-35.5		17.5-20.5
COM YDS	COL SQ. FT.	CU. FT.	QTY/CT	LBS.
1.25	22.5	10	1	25.35

task chair-gas lift/swivel-steel frame seat shell with rigid polyurethane cold cured foam-standard in polished chrome (ML 00) or black powder coat (ML 03)-top and/or single stitched based on COM

NOTE: FABRIC MUST BE APPROVED FOR APPLICATION-4 WAY STRETCH REQUIRED-minimum quantity required: 10-multiple base options available



**Bar Stool
OLIVER**

W	D	H	AH	SH
17.75	20.5	39.5		30
COM YDS	COL SQ. FT.	CU. FT.	QTY/CT	LBS.
1.25	22.50	12	1	21

bar stool-steel frame seat shell with rigid polyurethane cold cured foam-beech wood base/legs-top and/or single stitched based on COM

NOTE: FABRIC MUST BE APPROVED FOR APPLICATION-4 WAY STRETCH REQUIRED-minimum quantity required: 10-multiple base options available





**Side Chair-Metal
OLIVER**

W	D	H	AH	SH
18.25	21.75	33.25		18.5
COM YDS	COL SQ. FT.	CU. FT.	QTY/CT	LBS.
1.25	22.5	10	1	25.13

side chair-steel frame seat shell with rigid polyurethane cold cured foam-standard in polished chrome (ML 00) or black powder coat (ML 03)-top and/or single stitched based on COM

NOTE: FABRIC MUST BE APPROVED FOR APPLICATION-4 WAY STRETCH REQUIRED-minimum quantity required: 10-multiple base options available



**Bar Stool-Metal
OLIVER**

W	D	H	AH	SH
17.5	20.75	40.5		30
COM YDS	COL SQ. FT.	CU. FT.	QTY/CT	LBS.
1.25	22.5	12	1	27.55

bar stool-steel frame seat shell with rigid polyurethane cold cured foam-standard in polished chrome (ML 00) or black powder coat (ML 03)-top and/or single stitched based on COM

NOTE: FABRIC MUST BE APPROVED FOR APPLICATION-4 WAY STRETCH REQUIRED-minimum quantity required: 10-multiple base options available





**Arm Chair
OVAL-PL**

W	D	H	AH	SH
24.5	24	34.5	26.5	18.5

COM YDS	COL SQ. FT.	CU. FT.	QTY/CT	LBS.
1.5	27	12	1	19.5

beech wood arm chair-tight back and seat-in back welt-out back w/
upholstered inset-seat single stitched





Lounge Chair
OVAL-PPL

W	D	H	AH	SH
27.75	25.75	31.5	23.75	16
COM YDS	COL SQ. FT.	CU. FT.	QTY/CT	LBS.
1.75	30	14.5	1	21

beech wood lounge chair-tight back and seat-in back welt-out back w/
upholstered inset-seat single stitched





Side Chair
OVAL-SD

W	D	H	AH	SH
18.5	23	34.5		18.5
COM YDS	COL SQ. FT.	CU. FT.	QTY/CT	LBS.
1.5	26	12	2	35

beech wood side chair-tight back and seat-in back and leg welt-out back w/upholstered inset-seat single stitched





Bar Stool
OVAL-SG

W	D	H	AH	SH
19	21	45		30.5

COM YDS	COL SQ. FT.	CU. FT.	QTY/CT	LBS.
1.5	26	11	1	22

beech wood bar stool-tight back and seat-in back and leg welt-out back w/upholstered inset-seat single stitched





PERLA-1-STANDARD
(no stretcher-no minimum order required)

**Side Chair
PERLA-1**

W	D	H	AH	SH
19	23.00	36.25		19.75
COM YDS	COL SQ. FT.	CU. FT.	QTY/CT	LBS.
1.50	25.50	12.36	2	46.30

beech wood side chair with tight seat and back-welt on frame-seat is top and/or single stitched based on COM-minimum order required with stretcher (as shown above)





**Arm Chair
PERLA-1P**

W	D	H	AH	SH
23	22.50	36.25	27.25	19.75
COM YDS	COL SQ. FT.	CU. FT.	QTY/CT	LBS.
1.50	25.50	13.07	1	30.86

beech wood arm chair with tight seat and back-welt on frame-seat is top and/or single stitched based on COM



**Side Chair
PILLA-STACKING**

W	D	H	AH	SH
22.25	20.50	33.50		18.50
COM YDS	COL SQ. FT.	CU. FT.	QTY/CT	LBS.
1.25	21.25	10.59	2	28.43

side chair-steel frame with rigid polyurethane cold cured shell-polished chrome base-stacking-7

NOTE: FABRICS MUST BE APPROVED FOR APPLICATION-4 WAY STRETCH REQUIRED-minimum quantity required: 10





**Bar Stool
PIPPA**

W	D	H	AH	SH
19	21.50	41.50		30
COM YDS	COL SQ. FT.	CU. FT.	QTY/CT	LBS.
1.50	27	13	1	22

bent wood bar stool with beech wood legs/base-tight seat and back-top and/or single stitched based on COM-black metal foot rail

NOTE: FABRICS MUST BE APPROVED FOR APPLICATION-4 WAY STRETCH REQUIRED



Side Chair
PIPPA

W	D	H	AH	SH
18	21.50	31		18.75
COM YDS	COL SQ. FT.	CU. FT.	QTY/CT	LBS.
1.50	27	9	1	18

bent wood side chair with beech wood legs/base-tight seat and back-top and/or single stitched based on COM

NOTE: FABRICS MUST BE APPROVED FOR APPLICATION-4 WAY STRETCH REQUIRED





**Bar Stool-Metal
PIPPA**

W	D	H	AH	SH
18.50	21.50	42		30
COM YDS	COL SQ. FT.	CU. FT.	QTY/CT	LBS.
1.50	27	13	1	23

bent wood bar stool with black metal legs/base (ML 03)-tight seat and back-top and/or single stitched based on COM-black metal foot rail

NOTE: FABRICS MUST BE APPROVED FOR APPLICATION-4 WAY STRETCH REQUIRED



Side Chair-Metal
PIPPA

W	D	H	AH	SH
18.50	21.50	31		18.50
COM YDS	COL SQ. FT.	CU. FT.	QTY/CT	LBS.
1.50	27	9	1	20

bent wood side chair with black metal legs/base (ML 03)-tight seat and back-top and/or single stitched based on COM

NOTE: FABRICS MUST BE APPROVED FOR APPLICATION-4 WAY STRETCH REQUIRED





**Sectional
PUNTO-R-Corner, L-Corner, C-Armless**

	W	D	H	AH	SH
R-Corner	27.50	27.50	27	27	17
L-Corner	27.50	27.50	27	27	17
C-Armless	27.50	27.50	27		17
	COM YDS	COL SQ. FT.	CU. FT.	QTY/CT	LBS.
R-Corner	3	54	14.25	1	53
L-Corner	3	54	14.25	1	53
C-Armless	3	54	9.00	1	40

bent wood out back with beech veneer and embedded in a black powder coated metal frame (ML 03) and molded foam seat-top stitched-right arm facing, left arm facing, and armless components-minimum quantity required: 4 single components





**Occasional Chair
QUINCY**

W	D	H	AH	SH
28.5	31	32.5		18
COM YDS	COL SQ. FT.	CU. FT.	QTY/CT	LBS.
3.5	63	13.25	1	47



occasional chair-steel frame with molded cold-cured polyurethane foam shell-black powder coated metal legs (FG-Black)-top stitched

NOTE: FABRICS MUST BE APPROVED FOR APPLICATION-STRETCH REQUIRED (shown in Ultrafabrics)-minimum quantity required: 2



**Lounge Chair
QUINCY**

W	D	H	AH	SH
34	32.75	31.5		18
COM YDS	COL SQ. FT.	CU. FT.	QTY/CT	LBS.
4.5	81	16.25	1	50



lounge chair-steel frame with molded cold-cured polyurethane foam shell-black powder coated metal legs (FG-Black)-top stitched

NOTE: FABRICS MUST BE APPROVED FOR APPLICATION-STRETCH REQUIRED (shown in Ultrafabrics)-minimum quantity required: 2



**Arm Chair
RAYMOND-262**

W	D	H	AH	SH
20	23.25	31	25	19

COM YDS	COL SQ. FT.	CU. FT.	QTY/CT	LBS.
2.5	42.5	11.30	1	26

beech wood arm chair with tight seat and back-top and/or single stitched based on COM-in back welt

NOTE: FABRICS MUST BE APPROVED FOR APPLICATION-4 WAY STRETCH REQUIRED





**Bar Stool
RAYMOND-263**

W	D	H	AH	SH
23	23	43		32
COM YDS	COL SQ. FT.	CU. FT.	QTY/CT	LBS.
2.5	42.5	15.22	1	27

beech wood bar stool with tight seat and back-top and/or single stitched based on COM-in back welt-metal foot rail

NOTE: FABRICS MUST BE APPROVED FOR APPLICATION-4 WAY STRETCH REQUIRED





Occasional Chair
RAYMOND-264

W	D	H	AH	SH
26	25	34		19

COM YDS	COL SQ. FT.	CU. FT.	QTY/CT	LBS.
3.25	55.25	13.67	1	35

beech wood occasional chair with tight seat and back-top and/or single stitched based on COM-in back welt

NOTE: FABRICS MUST BE APPROVED FOR APPLICATION-4 WAY STRETCH REQUIRED





Lounge Chair
RAYMOND-265

W	D	H	AH	SH
26	25	30		15
COM YDS	COL SQ. FT.	CU. FT.	QTY/CT	LBS.
3.25	55.25	13.77	1	35

beech wood lounge chair with tight seat and back-top and/or single stitched based on COM-in back welt

NOTE: FABRICS MUST BE APPROVED FOR APPLICATION-4 WAY STRETCH REQUIRED





**Arm Chair
RODNEY**

W	D	H	AH	SH
22	20.5	32	26.5	18.25
COM YDS	COL SQ. FT.	CU. FT.	QTY/CT	LBS.
1.5	27	11.5	1	23

beech wood arm chair-tight seat and back-welt at top of in/back only





**Arm Chair-Metal Base
ROVER-P**

W	D	H	AH	SH
20.5	24.5	32	25.75	18.5
COM YDS	COL SQ. FT.	CU. FT.	QTY/CT	LBS.
3	51	10.59	1	21

arm chair-steel frame with molded cold-cured polyurethane shell-metal base / legs-choice of FG brushed aluminum, black or white finishes-top and/or single stitched based on COM-no welt

NOTE: FABRICS MUST BE APPROVED FOR APPLICATION-4 WAY STRETCH REQUIRED-minimum quantity required: 10



**Side Chair-Metal Base
ROVER-S**

W	D	H	AH	SH
20.5	24.5	32		18.5
COM YDS	COL SQ. FT.	CU. FT.	QTY/CT	LBS.
2.5	42.5	10.59	1	18

side chair-steel frame with molded cold-cured polyurethane shell-metal base / legs-choice of FG brushed aluminum, black or white finishes-top and/or single stitched based on COM-no welt

NOTE: FABRICS MUST BE APPROVED FOR APPLICATION-4 WAY STRETCH REQUIRED-minimum quantity required: 10





Side Chair
SANDRA

W	D	H	AH	SH
18.75	22.25	33.5		18.5
COM YDS	COL SQ. FT.	CU. FT.	QTY/CT	LBS.
1.75	29.75	12.36	2	44.25

beech wood side chair-tight seat and back-welt at in/out back



**Arm Chair
SANDRA-C**

W	D	H	AH	SH
21.75	23	33.5	25.25	18.5
COM YDS	COL SQ. FT.	CU. FT.	QTY/CT	LBS.
1.75	29.75	12.36	1	24.25

beech wood arm chair-tight seat and back-welt at in/out back



Bar Stool
SANDRA-SG

W	D	H	AH	SH
19	21.75	45.5		30.75
COM YDS	COL SQ. FT.	CU. FT.	QTY/CT	LBS.
1.5	25.50	13.42	1	26.5

beech wood bar stool-tight seat and back-welt at in/out back-metal foot rail



**Arm Chair
SCOOP-C**

W	D	H	AH	SH
23.5	21.75	31.5		18.5
COM YDS	COL SQ. FT.	CU. FT.	QTY/CT	LBS.
		10.59	1	14.5

arm chair-steel tube base-seat shell in injection molded polypropylene
(colors PP 20, PP 80, PP 70)
multiple base options available
choice of frame colors-see finish chart (ML 00, ML 01, ML 02, ML 03)



**Arm Chair
SCOOP-FP**

W	D	H	AH	SH
23.5	21.75	31.25		18.5
COM YDS	COL SQ. FT.	CU. FT.	QTY/CT	LBS.
		10.59	1	20.5

arm chair-ash wood multilayer frame-seat shell in injection molded polypropylene (PP 20, PP 80, PP 70)
multiple base options available



**Arm Chair
SCOOP-SL**

W	D	H	AH	SH
23.5	21.75	30.5		18.25
COM YDS	COL SQ. FT.	CU. FT.	QTY/CT	LBS.
		10.59	1	15.5

arm chair-steel tube base-seat shell in injection molded polypropylene
(colors PP 20, PP 80, PP 70)
multiple base options available
choice of frame colors-see finish chart (ML 00, ML 01, ML 02, ML 03)



**Arm Chair
SCOOP-TRC**

W	D	H	AH	SH
23.5	21.75	30.5		18.25

COM YDS	COL SQ. FT.	CU. FT.	QTY/CT	LBS.
		10.59	1	15

arm chair-steel tube base-seat shell in injection molded polypropylene
(colors PP 20, PP 80, PP 70)
multiple base options available
choice of frame colors-see finish chart (ML 00, ML 01, ML 02, ML 03)



**Side Chair Low
SEMPRE-9236-S**

W	D	H	AH	SH
20.75	24.5	34.25		18.5
COM YDS	COL SQ. FT.	CU. FT.	QTY/CT	LBS.
2	34	19.78	2	55

beech wood frame base and fully upholstered tight seat and back-top and/or single stitched based on COM





Side Chair High
SEMPRE-9235-S

W	D	H	AH	SH
20.75	26.25	54		18.5
COM YDS	COL SQ. FT.	CU. FT.	QTY/CT	LBS.
5	90	20.5	1	44

beech wood frame base and fully upholstered tight seat and back-top and/or single stitched based on COM





**Side Chair
SERENA**

W	D	H	AH	SH
19	22.50	34.75		19.00

COM YDS	COL SQ. FT.	CU. FT.	QTY/CT	LBS.
1.25	17	11.30	2	39.68

beech wood side chair with tight seat and back-in back/out back welt-seat is top and/or single stitched based on COM



**Arm Chair
SERENA-P**

W	D	H	AH	SH
23	23.75	34.75	26.75	18.25
COM YDS	COL SQ. FT.	CU. FT.	QTY/CT	LBS.
1.25	21.25	11.30	1	26.46

beech wood arm chair with tight seat and back-in back/out back welt-seat is top and/or single stitched based on COM





**Lounge Chair
SOLO**

W	D	H	AH	SH
36.75	26.5	46		17.75
COM YDS	COL SQ. FT.	CU. FT.	QTY/CT	LBS.
5/2.5	135	26.50	1	31

high upholstered paneled lounge chair with polished nickel base/legs and special anti-corrosive protective top coat-top stitched-minimum quantity required: 2





**Arm Chair
STRING-1-STACKING**

W	D	H	AH	SH
22	22	29.75	27.75	18.5
COM YDS	COL SQ. FT.	CU. FT.	QTY/CT	LBS.
1.25	21.25	8.48	1	21

beech wood arm chair with tight seat and back-stacking 4





Bar Stool
STRING-1-SG

W	D	H	AH	SH
20	21.25	37.5		30
COM YDS	COL SQ. FT.	CU. FT.	QTY/CT	LBS.
1.25	21.25	10.6	1	24

beech wood bar stool with tight seat and back-metal foot rail





**Arm Chair
STRING B-STACKING**

W	D	H	AH	SH
22	22	29.75	27.75	18.50

COM YDS	COL SQ. FT.	CU. FT.	QTY/CT	LBS.
1.25	21.25	8.48	1	21

beech wood arm chair with tight seat-inset upholstery and wood back-stacking-4



**Arm Chair
SUNNY-PB**

W	D	H	AH	SH
19	22.5	33		18.75

COM YDS	COL SQ. FT.	CU. FT.	QTY/CT	LBS.
1.75	29.75	11.30	1	27

beech wood arm chair with tight seat and upholstered in-back only-welt at in back-top and/or single stitched based on COM



**Arm Chair
SUNNY-PC**

W	D	H	AH	SH
21	22	33		18.75
COM YDS	COL SQ. FT.	CU. FT.	QTY/CT	LBS.
2	34	11.30	1	27

beech wood arm chair with tight seat and upholstered in-and out back-welt at in back-top and/or single stitched based on COM



**Side Chair
SUNNY-SB**

W	D	H	AH	SH
19	22.5	33		18.75
COM YDS	COL SQ. FT.	CU. FT.	QTY/CT	LBS.
1.5	25.5	14.83	2	45

beech wood side chair with tight seat and upholstered in-back wood out back-welt at in back-top and/or single stitched based on COM





**Side Chair
SUNNY-SC**

W	D	H	AH	SH
19	22.5	33		18.75

COM YDS	COL SQ. FT.	CU. FT.	QTY/CT	LBS.
1.5	25.5	14.83	2	45

beech wood side chair with tight seat and upholstered in-and out back-welt at in back-top and/or single stitched based on COM



**Bar Stool
SUNNY-SG-SB**

W	D	H	AH	SH
18	20	42		31

COM YDS	COL SQ. FT.	CU. FT.	QTY/CT	LBS.
1.5	25.5	12.71	1	25

beech wood bar stool with tight seat and upholstered in-back on-ly-welt at in back-top and/or single stitched based on COM-metal foot rail





Bar Stool
SUNNY-SG-SC

W	D	H	AH	SH
18	20	42		31

COM YDS	COL SQ. FT.	CU. FT.	QTY/CT	LBS.
1.5	25.5	12.71	1	25

beech wood bar stool with tight seat and upholstered in and out back-welt at in back-top and/or single stitched based on COM-metal foot rail



**Side Chair
TAMMY-C**

W	D	H	AH	SH
19.5	20.5	32		18.5
COM YDS	COL SQ. FT.	CU. FT.	QTY/CT	LBS.
		9.18	4	11

side chair-steel tube base-seat shell in injection molded polypropylene (PP 20, PP 80, PP 70)
multiple base options available-KD-assembly required
choice of frame colors-see finish chart (ML 00, ML 01, ML 02, ML 03)
minimum order required-qty.4



Side Chair
TAMMY-OMC

W	D	H	AH	SH
19.5	20.5	32		18.5
COM YDS	COL SQ. FT.	CU. FT.	QTY/CT	LBS.
		13.07	2	11

side chair-solid ash wood frame-seat shell in injection molded polypropylene (PP 20, PP 80, PP 70)
multiple base options available



**Bar Stool
TAMMY-SH**

W	D	H	AH	SH
15	15	34.5-42		24.75-32.25

COM YDS	COL SQ. FT.	CU. FT.	QTY/CT	LBS.
		4.24	1	21

bar stool-swivel seat in die cast aluminum-column in steel tube-height adjustable-gas lift and round base
 seat in injection molded polypropylene (colors PP 20, PP 80, PP 70)
 multiple base options available-KD-assembly required
 choice of frame colors-see finish chart (ML 00, ML 01, ML 02, ML 03)



**Side Chair
TAMMY-SL**

W	D	H	AH	SH
18	20.5	31.5		18.5
COM YDS	COL SQ. FT.	CU. FT.	QTY/CT	LBS.
		13.07	2	12

side chair-steel tube base-seat shell in injection molded polypropylene (PP 20, PP 80, PP 70)
multiple base options available
choice of frame colors-see finish chart (ML 00, ML 01, ML 02, ML 03)



**Side Chair
TAMMY-TRC**

W	D	H	AH	SH
19	20.5	31.5		18.5
COM YDS	COL SQ. FT.	CU. FT.	QTY/CT	LBS.
		13.07	2	11

side chair-steel tube base-seat shell in injection molded polypropylene (PP 20, PP 80, PP 70)
multiple base options available
choice of frame colors-see finish chart (ML 00, ML 01, ML 02, ML 03)



**Arm Chair
TIMELESS-P**

W	D	H	AH	SH
22	22.5	32.25	26.25	18.75

COM YDS	COL SQ. FT.	CU. FT.	QTY/CT	LBS.
2.5	42.5	11.30	1	25

beech wood arm chair with tight seat and back-top stitch



Side Chair
TIMELESS-S

W	D	H	AH	SH
22	22.5	32.25		18.75
COM YDS	COL SQ. FT.	CU. FT.	QTY/CT	LBS.
2.5	42.5	11.30	1	23

beech wood side chair with tight seat and back-top stitch



Bar Stool
TIMELESS-SG

W	D	H	AH	SH
22	22.5	42		30.25

COM YDS	COL SQ. FT.	CU. FT.	QTY/CT	LBS.
2.5	42.5	14.13	1	29

beech wood bar stool with tight seat and back-top stitch



Side Chair
TORMALINA-1

W	D	H	AH	SH
20.00	22.50	32.75		18.50
COM YDS	COL SQ. FT.	CU. FT.	QTY/CT	LBS.
2.00	34.00	13.07	1.00	24.25

beech wood side chair with tight seat and back-welt-top and/or single stitched based on COM



**Arm Chair
TORMALINA-1P**

W	D	H	AH	SH
24.00	22.50	32.75	25.75	18.50
COM YDS	COL SQ. FT.	CU. FT.	QTY/CT	LBS.
2.50	42.50	13.07	1.00	24.25

beech wood arm chair with tight seat and back-welt-top and/or single stitched based on COM





**Bar Stool
TORMALINA-1SG**

W	D	H	AH	SH
18.75	19.75	43.50		31.50
COM YDS	COL SQ. FT.	CU. FT.	QTY/CT	LBS.
1.75	29.75	10.59	1.00	35.27

beech wood bar stool with tight seat and back-welt-top and/or single stitched based on COM-metal foot rail



Side Chair
TORMALINA

W	D	H	AH	SH
20.25	21.75	34.50		18.50
COM YDS	COL SQ. FT.	CU. FT.	QTY/CT	LBS.
2.00	34.00	13.07	1.00	26.46

beech wood side chair with tight seat and back-welt-top and/or single stitched based on COM





**Bar Stool
TORMALINA-SG**

W	D	H	AH	SH
18.75	19.75	43.50		31.50
COM YDS	COL SQ. FT.	CU. FT.	QTY/CT	LBS.
1.75	29.75	10.59	1.00	24.25

beech wood bar stool with tight seat and back-welt-top and/or single stitched based on COM-metal foot rail





**Arm Chair
TORMALINA-3P**

W	D	H	AH	SH
23	24.75	32.25	26	18.50
COM YDS	COL SQ. FT.	CU. FT.	QTY/CT	LBS.
2.25	38.25	13.07	1	30.86

beech wood arm chair with tight seat and back-welt-top and/or single stitched based on COM



**Occasional Chair
TOTO**

W	D	H	AH	SH
29	28	33		18
COM YDS	COL SQ. FT.	CU. FT.	QTY/CT	LBS.
3	51	19.42	1	35

beech wood occasional chair-tight seat and back-no welt-top and/or single stitched based on COM-in back and out back seams



Side Chair
TOTO

W	D	H	AH	SH
23	22	31		19
COM YDS	COL SQ. FT.	CU. FT.	QTY/CT	LBS.
2.25	38.25	11.65	1	25

beech wood side chair-tight seat and back-no welt-top and/or single stitched based on COM-in back and out back seams



**Arm Chair-Metal
VIDAL**

W	D	H	AH	SH
21.75	21.25	33.50	24	18.50
COM YDS	COL SQ. FT.	CU. FT.	QTY/CT	LBS.
2	36	12	1	20

bent wood arm chair with black metal legs/base (ML 03)-tight seat and back-top and/or single stitched based on COM





**Bar Stool-Metal
VIDAL**

W	D	H	AH	SH
21.75	21.25	44.50	35	30
COM YDS	COL SQ. FT.	CU. FT.	QTY/CT	LBS.
2	36	14	1	24

bent wood bar stool with black metal legs/base (ML 03)-tight seat and back-top and/or single stitched based on COM-black metal foot rail



Occasional Chair
VIDRA-XL

W	D	H	AH	SH
23.25	23.75	30.75		18.50
COM YDS	COL SQ. FT.	CU. FT.	QTY/CT	LBS.
1.25	21.25	12.36	1	39.68

beech wood occasional chair with tight seat and back-welt on frame-top and/or single stitched based on COM





**Arm Chair
VILLA-9167-A**

W	D	H	AH	SH
23.75	24.5	33.75	26.5	18
COM YDS	COL SQ. FT.	CU. FT.	QTY/CT	LBS.
2	34	15.89	1	32

beech wood arm chair with tight seat and back-welt





Bar Stool
VILLA-9167-B

W	D	H	AH	SH
20	20	39.25		30
COM YDS	COL SQ. FT.	CU. FT.	QTY/CT	LBS.
2	34	15.19	1	50

beech wood barstool with tight seat and back-welt-stainless steel foot rail



Side Chair
VILLA-9167-S

W	D	H	AH	SH
22.75	24.5	33.75		18
COM YDS	COL SQ. FT.	CU. FT.	QTY/CT	LBS.
2	34	17.66	2	46

beech wood side chair with tight seat and back-welt





**Arm Chair-Metal
VIVIAN**

W	D	H	AH	SH
24	24	31.50	28	19.25
COM YDS	COL SQ. FT.	CU. FT.	QTY/CT	LBS.
2.50	45	14.25	1	40

bent wood arm chair-tight seat and back-no welt-top and/or single stitched based on COM-powder coated metal base/legs in black (ML 03), white (FG White) and grey (TL-Grey)





**Lounge Chair
WILLIAM**

W	D	H	AH	SH
31.5	28	33	22.5	18
COM YDS	COL SQ. FT.	CU. FT.	QTY/CT	LBS.
3.5	63	13.25	1	45



lounge chair-steel frame with molded cold-cured polyurethane foam shell-black powder coated metal legs (FG-Black)-top stitched

NOTE: FABRICS MUST BE APPROVED FOR APPLICATION-STRETCH REQUIRED (shown in Ultrafabrics)-minimum quantity required: 2



**Loveseat
WILLIAM**

W	D	H	AH	SH
60	30	31.5	22.5	17.5
COM YDS	COL SQ. FT.	CU. FT.	QTY/CT	LBS.
4.5	81	33.50	1	93



loveseat-steel frame with molded cold-cured polyurethane foam shell-
black powder coated metal legs (FG-Black)-top stitched

NOTE: FABRICS MUST BE APPROVED FOR APPLICATION-STRETCH
REQUIRED (shown in Ultrafabrics)



**Arm Chair
ZIGGY**

W	D	H	AH	SH
21	22	28.50	26.75	18.50
COM YDS	COL SQ. FT.	CU. FT.	QTY/CT	LBS.
		12.50	2	31

beech wood arm chair-wood seat and back with black (ML 03) or white (FG White) powder coated metal frame-stacks 5





**Arm Chair
ZIGGY-1**

W	D	H	AH	SH
21	22	28.50	26.75	18.50
COM YDS	COL SQ. FT.	CU. FT.	QTY/CT	LBS.
1	18	12.50	2	31

beech wood arm chair-upholstered back and seat with black (ML 03) or white (FG White) powder coated metal frame-stacks 4



**Arm Chair
ZIGGY-S**

W	D	H	AH	SH
21	22	28.50	26.75	18.50
COM YDS	COL SQ. FT.	CU. FT.	QTY/CT	LBS.
.75	13.50	12.50	2	31

beech wood arm chair-wood back and upholstered seat with black (ML 03) or white (FG White) powder coated metal frame-welt at in-back-stacks 4



Coffee Table - Oval
MADRE

W	D	H	AH	SH
40	24	18		
COM YDS	COL SQ. FT.	CU. FT.	QTY/CT	LBS.
		5	1	48

beech wood coffee table-beech veneer top-KD-easy assembly required



End Table - Round
MADRE

W	D	H	AH	SH
24D		24		
COM YDS	COL SQ. FT.	CU. FT.	QTY/CT	LBS.
		2	1	18

beech wood end table-beech veneer top-KD-easy assembly required



Coffee Table
MICAH

W	D	H	AH	SH
43	24	18		
COM YDS	COL SQ. FT.	CU. FT.	QTY/CT	LBS.
		13.5	1	70



coffee table-beech wood (Natural wood finish not available)
minimum quantity required: 4-optional wood species available



End Table
MICAH

W	D	H	AH	SH
24	24	26		
COM YDS	COL SQ. FT.	CU. FT.	QTY/CT	LBS.
		10	1	45

end table-beech wood (Natural wood finish not available)-minimum quantity required: 4-optional wood species available





End Table - Round
MONTY

W	D	H	AH	SH
24 D		22		
COM YDS	COL SQ. FT.	CU. FT.	QTY/CT	LBS.
		7	1	25

end table-european beech



End Table - Square
MONTY

W	D	H	AH	SH
24	24	22		

COM YDS	COL SQ. FT.	CU. FT.	QTY/CT	LBS.
		7	1	35

end table-european beech



End Table
PLAZA

W	D	H	AH	SH
22 D		22		
COM YDS	COL SQ. FT.	CU. FT.	QTY/CT	LBS.
		8.5	1	30

end table-european beech



Coffee Table
SOHO

W	D	H	AH	SH
36	36	18		
COM YDS	COL SQ. FT.	CU. FT.	QTY/CT	LBS.
		20	1	40

coffee table-european beech (natural wood finish not available)



End Table
SOHO

W	D	H	AH	SH
22	22	18		
COM YDS	COL SQ. FT.	CU. FT.	QTY/CT	LBS.
		8.5	1	30

end table-european beech (natural wood finish not available)



**Table Base - Coffee Table - BASE ONLY
CAGE**

W	D	H	AH	SH
12D		16.5		
COM YDS	COL SQ. FT.	CU. FT.	QTY/CT	LBS.
		7.77	1	13.5

steel tube coffee table-BASE ONLY-max.size top 165"-max.weight top 15 lbs.-
choice of frame colors-see finish chart (ML 01, ML 03)



Table Base - Dining Table - BASE ONLY
CAGE

W	D	H	AH	SH
25.75	D	28.75		
COM YDS	COL SQ. FT.	CU. FT.	QTY/CT	LBS.
		22.95	1	93

steel tube dining table-BASE ONLY-max size top 48"-max weight top-120 lbs.
choice of frame colors-see finish chart (ML 01, ML 03)



Table Base - End Table - BASE ONLY
CAGE

W	D	H	AH	SH
14D		20.5		
COM YDS	COL SQ. FT.	CU. FT.	QTY/CT	LBS.
		10.59	1	23.25

steel tube end table-BASE ONLY-max. size top 16.5"-max.weight top 25 lbs.
choice of frame colors-see finish chart (ML 01, ML 03)



**Table Base - Dining Table - BASE ONLY
GANTY**

W	D	H	AH	SH
15.75 D		29		
COM YDS	COL SQ. FT.	CU. FT.	QTY/CT	LBS.
		6	1	57

round dining table-BASE ONLY-stainless steel (M1-satin) w/wood column for 32" or 36" top-base and column ship KD-easy assembly required



**Table Base - Dining Table - BASE ONLY
GANTY**

W	D	H	AH	SH
15.75	15.75	29		
COM YDS	COL SQ. FT.	CU. FT.	QTY/CT	LBS.
		6	1	57

square dining table-BASE ONLY-stainless steel (M1-satin) w/wood column for 32" or 36" top-base and column ship KD-easy assembly required



Table Base - Bar Table - BASE ONLY
TB-256-BT-SS

W	D	H	AH	SH
19.75	19.75	41		

COM YDS	COL SQ. FT.	CU. FT.	QTY/CT	LBS.
		11	1	68.5

square bar table-BASE ONLY-stainless steel (shown in M1-satin)
@ 42" ht using a 1" thick top-28" or 32" top
minimum order required of 6 bases (various or same size)

also available: TB-256-BT-PC powder coated



**Table Base - Dining Table - BASE ONLY
TB-256-DT-SS**

W	D	H	AH	SH
19.75	19.75	29		
COM YDS	COL SQ. FT.	CU. FT.	QTY/CT	LBS.
		8	1	65.5

square dining table-BASE ONLY-stainless steel (shown in M1-satin)
@ 30" ht using a 1" thick top-max. top 36"
minimum order required of 6 bases (various or same size)

also available: TB-256-DT-PC powder coated



Table Base - End Table - BASE ONLY
TB-256-ET-SS

W	D	H	AH	SH
15.75	15.75	21		
COM YDS	COL SQ. FT.	CU. FT.	QTY/CT	LBS.
		4	1	44.25

square end table-BASE ONLY-stainless steel (shown in M1-satin)
@ 22" ht using a 1" thick top-max. top 22"
minimum order required of 6 bases (various or same size)

also available: TB-256-ET-PC powder coated



Table Base - End Table - BASE ONLY
TB-290-1-ET-SS

W	D	H	AH	SH
15.75 D		21		
COM YDS	COL SQ. FT.	CU. FT.	QTY/CT	LBS.
		4	1	35.5

round end table-BASE ONLY-stainless steel (shown in M1-satin)
@ 22" ht using a 1" thick top-max. top 22"

minimum order required of 6 bases (various or same size)
tops ship separately from base-KD w/assembly required

also available: TB-290-1-ET-PC powder coated



Table Base - Bar Table - BASE ONLY
TB-290-3-BT-SS

W	D	H	AH	SH
19.75	D	41		

COM YDS	COL SQ. FT.	CU. FT.	QTY/CT	LBS.
		11	1	56.5

round bar table-BASE ONLY-stainless steel (shown in M1-satin)
@ 42" ht using a 1" thick top-28" or 32" top

minimum order required of 6 bases (various or same size)
tops ship separately from base-KD w/assembly required

also available: TB-290-3-BT-PC powder coated



**Table Base - Dining Table - BASE ONLY
TB-290-3-DT-SS**

W	D	H	AH	SH
19.75	D	29		
COM YDS	COL SQ. FT.	CU. FT.	QTY/CT	LBS.
		8	1	54

round dining table-BASE ONLY-stainless steel (shown in M1-satin)
@ 30' ht using a 1" thick top-max.top 36"

minimum order required of 6 bases (various or same size)
tops ship separately from base-KD w/assembly required

also available: TB-290-3-DT-PC powder coated



**Table Base - Coffee Table - BASE ONLY
TB-355-1-CT-PC**

W	D	H	AH	SH
18 D		17		

COM YDS	COL SQ. FT.	CU. FT.	QTY/CT	LBS.
		4	1	47.50

round coffee table-BASE ONLY-powder coated (std. in M6-black or M4-white) @ 18" ht. using a 1" thick top-max top 24"
minimum order required of 6 bases (various or same size)

also available: TB-355-1-CT-SS stainless steel



Table Base - End Table - BASE ONLY
TB-355-1-ET-PC

W	D	H	AH	SH
18 D		21		

COM YDS	COL SQ. FT.	CU. FT.	QTY/CT	LBS.
		4	1	48.5

round end table-BASE ONLY-powder coated (std. in M6-black or M4-white) @ 22" ht. using a 1" thick top-max. top 24"
minimum order required of 6 bases (various or same size)

also available: TB-355-1-ET-SS stainless steel



**Table Base - Bar Table - BASE ONLY
TB-355-2-BT-PC**

W	D	H	AH	SH
19.75	D	41		

COM YDS	COL SQ. FT.	CU. FT.	QTY/CT	LBS.
		11	1	64

round bar table-BASE ONLY-powder coated (std. in M6-black or M4-white) @ 42" ht. using a 1" thick top-28" or 32" top
minimum order required of 6 bases (various or same size)

also available: TB-355-2-BT-SS stainless steel



Table Base - Dining Table - BASE ONLY
TB-355-2-DT-SS

W	D	H	AH	SH
19.75	D	29		

COM YDS	COL SQ. FT.	CU. FT.	QTY/CT	LBS.
		8	1	60

round dining table-BASE ONLY-stainless steel (shown in M1-satin)
@ 30" ht using a 1" thick top-max. top 36"
minimum order required of 6 bases (various or same size)

also available: TB-355-2-DT-PC powder coated



Table Base - Dining Table - BASE ONLY
TB-355-3-DT-PC

W	D	H	AH	SH
23.75 D		29		
COM YDS	COL SQ. FT.	CU. FT.	QTY/CT	LBS.
		11	1	85

round dining table-BASE ONLY-powder coated (std. in M6-black or M4-white) @ 30" ht using a 1" thick top-max. top 48"
minimum order required of 6 bases (various or same size)

also available: TB-355-3-DT-SS stainless steel

CUSTOM CAPABILITIES

In addition to an extensive inventory of exceptional European frame-designed, American-made seating products, Motivo Furniture also offers a wide range of custom capabilities that reflect the company's high design standards and manufacturing excellence.

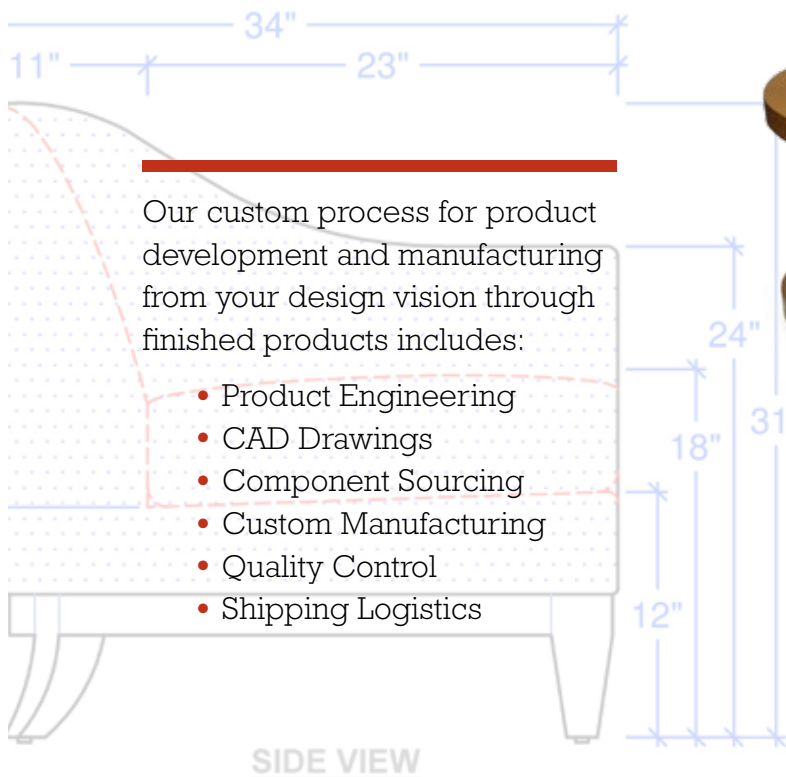

Our custom manufacturing capabilities include exposed wood, mixed materials or fully upholstered seating, as well as occasional tables. Motivo's capacity, capabilities and experience are the perfect choice for public areas, guestrooms, suites, restaurants, clubs, offices or healthcare.

PLAN VIEW



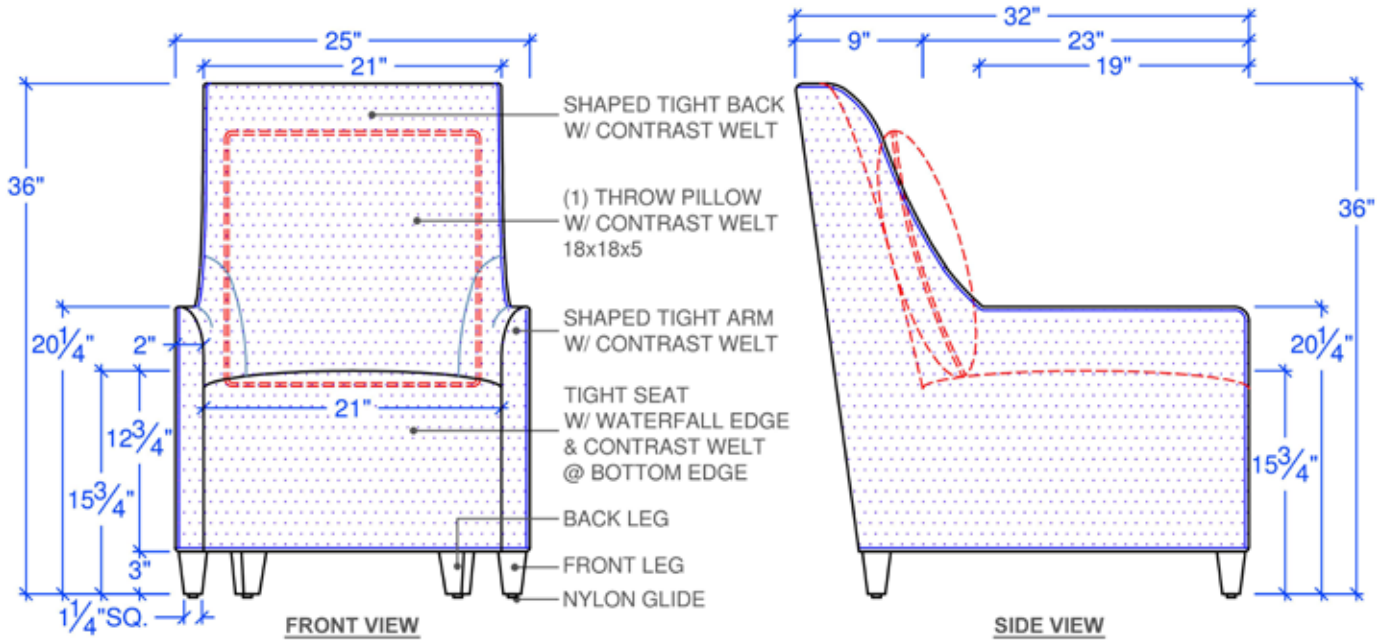

Motivo closely manages each step to ensure a seamless process through to the finished products that are right for your project, on time and on budget. Trust Motivo Furniture when American-made custom craftsmanship is essential to your creative vision. Visit www.motivofurniture.com for more information or to find a representative near you.

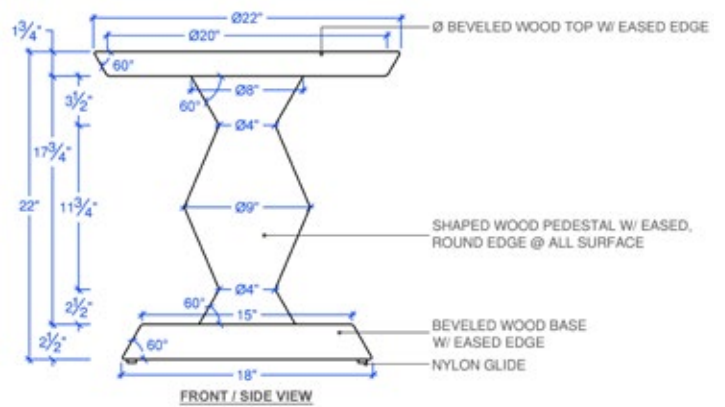
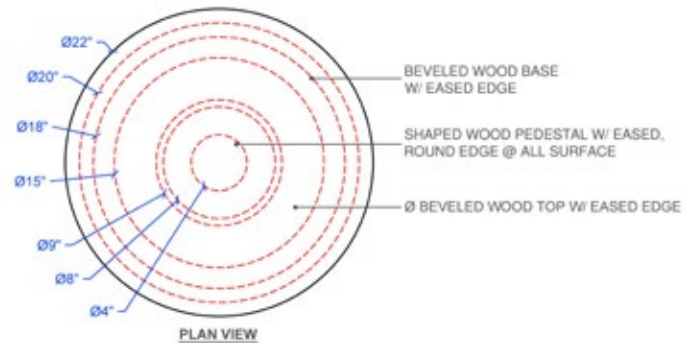

MOTIVO
furniture

Wood Finish Options

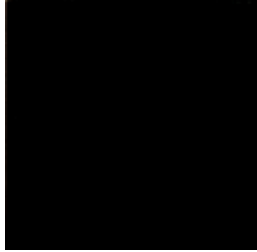

Black



Espresso

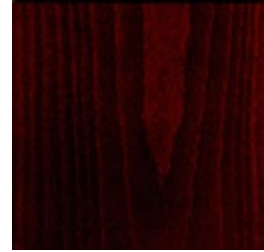

Mahogany



Dark Walnut

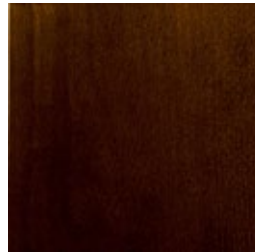

Medium Walnut



Fruitwood



Charcoal

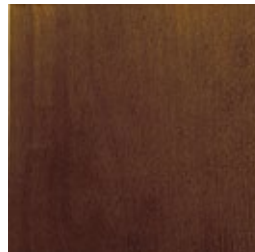

Light Walnut

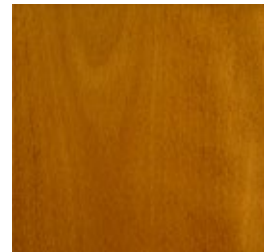

Honey

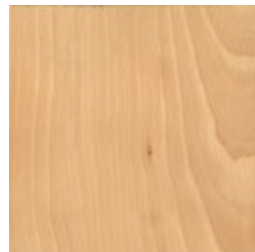

Natural

The finishes shown are representations of our available finishes. Please choose your finish based from an actual sample, as we cannot guarantee color accuracy on your computer screen or from printed files. Custom finishes to match a wood stain are available-See Up Charges in the price list.

Material Finish Options

Table Base and Chair Finishes



M1-Stainless Steel (satin)



M2-Chrome Satin



M3-Chrome



M4-White



M5-Grey



M6-Black

Metal Chair Leg / Base Finishes



ML00-Chrome



ML01-White



ML02-Taupe



ML03-Black



ML04-Satin Chrome

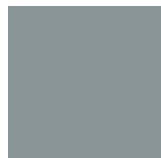

TL-Grey

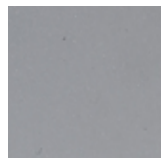

FG Brushed
Aluminum

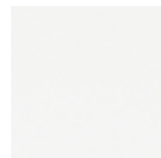

FG White



FG Black

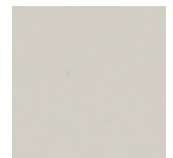

Polished
Nickel

Polypropylene Chair Seat Finishes



PP20-White



PP80-Taupe

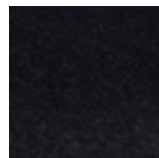

PP70-Black

The finishes shown are representations of our available finishes. Please choose your finish based from an actual sample, as we cannot guarantee color accuracy on your computer screen or from printed files.